

Installation and Control
Installation Manual
(original instructions)

EN

Panasonic[®]

N421124A - Rev.04 - 07-2025

Aquarea Air - Wall Mounted

P-FMM40*

First of all, we would like to thank you for having chosen a device of our production.

We are sure you will be happy with it because it represents the state of the art in the technology of home air conditioning.

By following the suggestions contained in this manual, the product you have purchased will provide trouble free operation, giving you optimum room temperatures with minimum energy costs.

Panasonic Corporation

Conformity

This unit complies with the European directives:

- Low voltage 2014/35 / EU
- EMC 2014/30/EU
- RoHS 2011/65/UE

Markings



TABLE OF CONTENTS

1. Coding	4		
1.1 Product related coding	4		
2. General information	5		
2.1 About the manual	5		
2.2 General warnings	6		
2.3 Basic rules of security	6		
2.4 Disposal	7		
3. Product presentation	8		
3.1 Identification	8		
3.2 Destination of use	8		
3.3 Description of the appliance	8		
3.4 Components	9		
3.5 Compatible accessories	10		
4. Installation	11		
4.1 Preliminary warnings	11		
4.2 Reception	11		
4.3 Dimensions and weights with packaging	11		
4.4 Handling with packaging	12		
4.5 Storage	12		
4.6 Unpacking	12		
4.7 Handling without packaging	13		
4.8 Installation site	13		
4.9 Installation mode	14		
4.10 Installation minimum distances	14		
4.11 Positioning	14		
4.12 Hydraulic connections	17		
4.13 Condensation drain preparation	18		
4.14 Filling the system	19		
4.15 Electric connections	20		
5. Touchpad and remote control	22		
5.1 Interface	22		
5.2 PCB	23		
5.3 Connections	24		
5.4 Functions	24		
6. Wall-mounted control Coding PCZ-EEB749	27		
6.1 Interface	27		
6.2 Installation	27		
		6.3 Single connection diagram	29
		6.4 Multiple connection diagram	30
		6.5 Connections	31
		6.6 Functions	32
		7. Wall-mounted control Coding PCZ-EFB749	37
		7.1 Interface	37
		7.2 Installation	37
		7.3 Single connection diagram	39
		7.4 Multiple connection diagram	40
		7.5 Connections	41
		7.6 Functions	42
		8. 0-10 V connection	47
		8.1 Connection diagram	47
		8.2 Connections	48
		8.3 Error signals	48
		9. Maintenance	49
		9.1 Preliminary warnings	49
		9.2 Routine maintenance	49
		9.3 External cleaning	49
		9.4 Air intake filter cleaning	50
		9.5 Suggestions for energy saving	50
		10. Troubleshooting	51
		10.1 Preliminary warnings	51
		10.2 Troubleshooting table	51
		11. Configuration accessories	52
		11.1 Shut-off valves	52
		12. Technical information	54
		12.1 Technical data	54
		12.2 Limits of product operation	55
		12.3 Limits of operation of the control	55
		12.4 Dimensions	55
		12.5 Installation template	56

1. CODING

1.1 Product related coding

This instruction manual refers to the following product codes.





⚠ Check the correspondence with the technical rating plate on the product. See chapter "Identification" *p. 8*.

Code	Size	Connection side	Control Panel	Valves
P-FMM40DC-R0E	40	Vertical right	Wall RC	-
P-FMM40DC-Q0E	40	Vertical right	On-board panel	-
P-FMM40DC-V0E	40	Vertical right	0-10 V	-
P-FMM40DC-RNE	40	Vertical right	Wall RC	Auto 3 way
P-FMM40DC-QNE	40	Vertical right	On-board panel	Auto 3 way

2. GENERAL INFORMATION

2.1 About the manual





This manual was written to provide all the explanations for the correct management of the device.

-  This instruction manual forms an integral part of the device and therefore must be carefully preserved and must ALWAYS travel with it, even if you transfer the device to another owner or relocate it to other premises. If the manual gets damaged or lost, download a copy from the website.
-  Read this manual carefully before proceeding with any operation and follow the instructions in the individual chapters.
-  The Manufacturer accepts no liability for damages to persons or property caused by failure to follow the instructions in this manual.
-  This document is restricted in use to the terms of the law and may not be copied or transferred to third parties without the express authorisation of the Manufacturer.

2.1.1 Editorial pictograms

The pictograms in the next chapter provide the necessary information for correct and safe use of the machine in a rapid and unmistakable way.

Related to security

-  **High risk warning (bold text)**
 - The operation described above presents a risk of serious physical injury, fatality, major damage to the device and/or to the environment if not carried out in compliance with safety regulations.
-  Low risk warning (plain text)
 - The operation described above presents a risk of minor physical injury or minor damage to the device and/or to the environment if not carried out in compliance with safety regulations.
-  Prohibition (plain text)
 - Refers to prohibited actions.
-  **Important information (bold text)**
 - This indicates important information that must be taken into account during the operations.



In the texts

- ▶ procedures
- lists

In the control panels

- ▶ actions required
- Expected responses following an action.*

In the figures

- 1 The numbers indicate the individual components.
- A The capital letters indicate component assemblies.
-  The white numbers in black marks indicate a series of actions to be carried out in sequence.
-  The black letter in white identifies an image when there are several images in the same figure.

2.1.2 Pictograms on the product

Symbols are used in some parts of the device:

Related to security



Read instruction manual

Read the instructions carefully before performing any work on the device.



Instruction manual

Read the information available in the technical documentation of the device.



Caution: electrical danger

- The concerned personnel is informed to the presence of electricity and the risk of suffering an electric shock.

2.1.3 Recipients

User

Non-expert person capable of operating the product in safe conditions for people, for the product itself and the environment, interpreting an elementary diagnostic of faults and abnormal operating conditions, carrying out simple adjustment, checking and maintenance operations.

Installer

Expert person qualified to position and connect (hydraulically, electrically, etc.) the unit to the plant; this person is responsible for handling and correct installation according to the instructions provided in this manual and the national standards currently in force.

Authorized Service Center

Expert and qualified person authorised directly by the manufacturer to carry out all routine and supplementary maintenance operations, as well as every adjustment, check, repair and replacement of parts necessary during the life of the unit itself.

2.1.4 Manual organization

The manual is divided into sections each dedicated to one or more target groups.

General information

It addresses all recipients.
It contains general information and important warnings that should be known before installing and using the device.

Product presentation

It addresses all recipients.
It contains the information to identify the product, its components, compatible accessories and destination of use.

Installation

It is addressed exclusively to the installer.
It contains specific warnings and all the information necessary for positioning, mounting and connecting the appliance.

Commissioning, maintenance and troubleshooting

They are addressed exclusively to the Authorized Service Center.
It contains specific warnings useful information for the most common commissioning and routine maintenance.

Configuration accessories

It is addressed to the installer and the Authorised Service Centre.
It contains specific warnings and all detailed information on configuration accessories.

Technical information

It addresses all recipients.
It contains detailed technical information about the appliance.

2.2 General warnings

- ⚠ Specific warnings are given in each chapter of the document and must be read before starting operations.
- ⚠ All personnel involved must be aware of the operations and dangers that may arise when beginning all unit installation operations.
- ⚠ Installation performed outside the warnings provided in this manual and use of the appliance outside the prescribed temperature limits will invalidate the warranty.
- ⚠ The installation and maintenance of climate control equipment can be dangerous due to live electrical components inside the appliances. The installation, initial start-up and subsequent maintenance phases must be carried out exclusively by authorized and qualified personnel (see first start-up request form enclosed with the appliance).
- ⚠ Any contractual or extra-contractual liability for damage caused to persons, animals or property, due to installation adjustment and maintenance errors, or improper use, is excluded. All uses not expressly indicated in this manual are not permitted.
- ⚠ Only suitably qualified installers are authorized to install the device. After having completed installation, the installer will issue a declaration of conformity to the plant manager, as required by the applicable standards and the guidelines provided by contractor's instruction manual supplied with the device.
- ⚠ First start-up and repair or maintenance operations must be carried out by the Technical Assistance Center or by qualified personnel following the provisions of this manual.
- ⚠ Do not modify or tamper with the appliance as this can lead to dangerous situations.
- ⚠ Use suitable personal protective clothing and equipment during installation and/or maintenance operations. The Manufacturer is not liable for the non-observance of the current safety and accident prevention regulations.
- ⚠ In the event of liquid or oil leaks, set the main switch of the plant to "OFF" and isolate water taps where applicable. Call the Authorized Service Center or professionally qualified personnel as soon as possible and do not work on the appliance yourself.
- ⚠ In case of replacement of parts, use only original parts.
- ⚠ The Manufacturer reserves the right to make changes to its models at any time to improve its product, without prejudice to the essential characteristics described in this manual. The manufacturer is not obliged to add such modifications to machines previously manufactured, already delivered or under construction.
- ⚠ The unit can be used by children over the age of 8, and by people with reduced physical, sensory or mental capabilities, or with no experience or necessary knowledge, as long as they are monitored or after they have received instructions on the safe use of the unit and have understood the dangers involved. Children must not play with the appliance. The cleaning and maintenance that must be performed by the user should not be carried out by children without supervision.

2.3 Basic rules of security

Please keep in mind that the use of products powered by electricity and water call for operators to comply with certain essential safety rules:

- ⊖ It is forbidden to touch the device with wet or damp body parts.
- ⊖ It is forbidden to carry out any operation before disconnecting the appliance from the power supply by setting the plant main switch to "OFF".
- ⊖ It is forbidden to modify the safety or adjustment devices, or adjust without authorization and indications of the Manufacturer.
- ⊖ It is forbidden to pull, unplug or twist the device's electric cables, even if it is disconnected from the mains.
- ⊖ It is forbidden to introduce objects and substances through the air inlet and outlet grilles.

- ⊖ It is forbidden to open the access doors of the device's internal parts without first having set main switch of the system to "OFF".
- ⊖ It is forbidden to incorrectly dispose of the packaging, or leave in the reach of children, which may become a source of danger.

2.4 Disposal

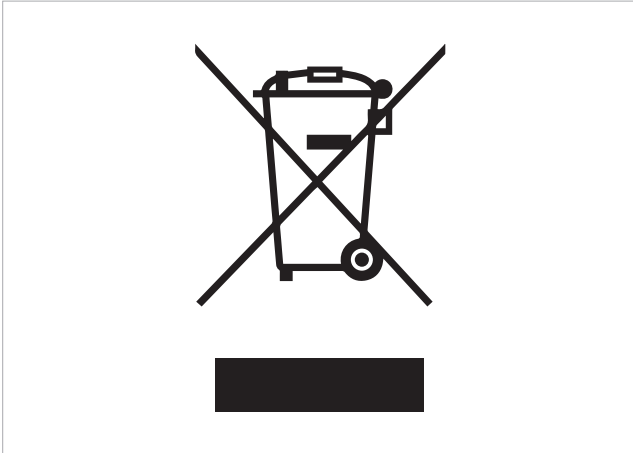

The symbol on the product or packaging indicates that the product must not be treated as normal household waste, but must be taken to the appropriate collection point for recycling of used electrical and electronic equipment and batteries.

Proper disposal of this product avoids harm to humans and the environment and promotes the reuse of valuable raw materials.

For more detailed information about the recycling of this product, contact your local authority, your household waste disposal service or the shop where you purchased the product.

Illegal disposal of the product by the user involves the application of the administrative sanctions provided for by the regulations in force.

This provision is valid in the EU Member States.

⚠ Avoid disassembling the unit yourself.

⚠ **Contact an Authorized Service Center to disassemble the appliance.**



This symbol might be used in combination with a chemical symbol.

In this case, it complies with the requirement set by the Directive for the chemical involved.

3. PRODUCT PRESENTATION

3.1 Identification

The appliance can be identified by the rating plate:

Technical rating plate

⚠ Tampering with, removal of, or lack of identification plates will not allow for the safe identification of the product by its serial number and therefore invalidates the warranty.

1. Technical rating plate

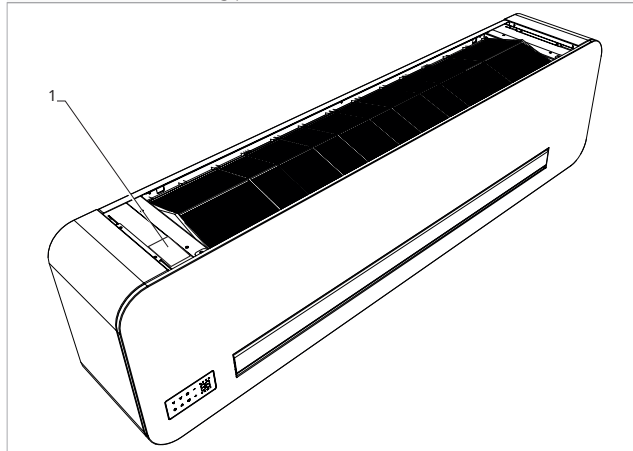

3.2 Destination of use

These appliances have been designed for conditioning and/or heating rooms and they must be destined solely for

this purpose, in accordance with their performance characteristics.

⊖ It is forbidden to use the device other than as indicated.

3.3 Description of the appliance

Aquarea Air - Wall Mounted fancoils range are designed for wall mounting.

The units are produced only in size 40, suitable for installation on two-pipe systems.

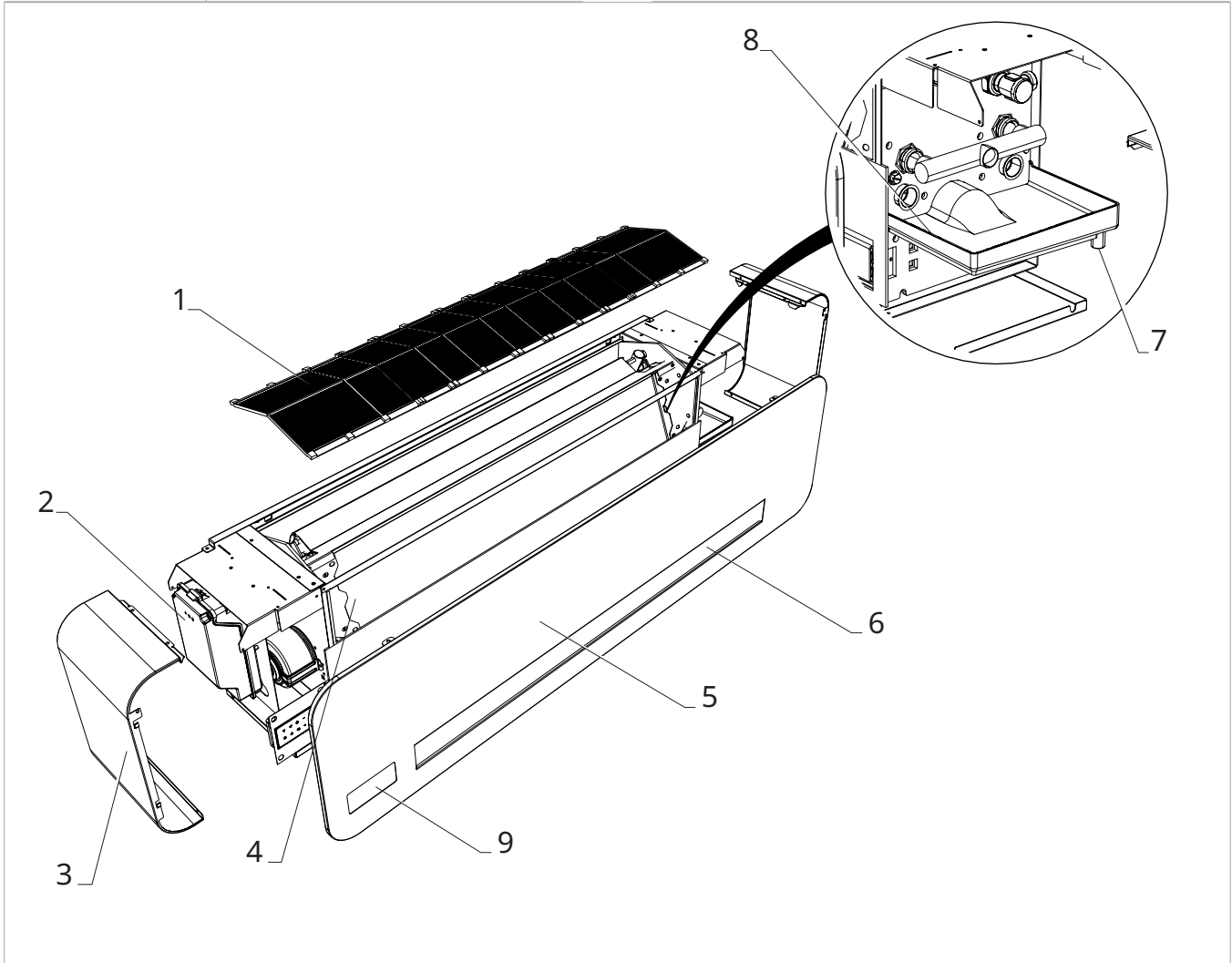

3.4 Components

1.	Air intake filter	6.	Air outlet deflector
2.	Electrical back box	7.	Ø 14 mm condensate drain
3.	Aesthetic sides	8.	Condensation drain tray
4.	Heat exchanger	9.	On-unit control panel predisposition (only available for some versions)
5.	Aesthetic front panel		

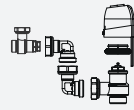

3.5 Compatible accessories

⚠ The accessories table refers to all products in the Wall Mounted range. Please check the column Combinable products for correspondence with the purchased size.

	Accessory description	Combinable products	Code
Wall-mounted control panels			
Control panels			
	LED electronic control panel with touch interface, wall mounted complete with thermostat and room temperature and relative humidity probe. Cable connection. White colour	All	PCZ-EEB749
	LED electronic control panel with touch interface, wall-mounted complete with thermostat and room temperature and relative humidity probe with integrated Wi-Fi module. Cable connection. White colour	All	PCZ-EFB749
Accessories supplied separately			
Modules			
	Electronic board for external terminal control (e.g. radiant panel or radiator valves). For connection to wall control units PCZ-EEB749 / PCZ-EFB749.	All	PCZ-EG1028
Valves			
HYDRAULIC KIT			
	3-way valve unit with thermoelectric motor	All	PCZ-V30718
	2-way valve unit with thermoelectric motor	All	PCZ-V20139

4. INSTALLATION

4.1 Preliminary warnings

- ⚠ **This section is dedicated to the Installer. The features of the installer are described in the "Recipients" p. 5 chapter.**
- ⚠ **For detailed information on the products, refer to chapter "Technical information" p. 54**
- ⚠ The installation must be carried out by the installer in accordance with national installation codes. There is a risk of water leakage, electric shock or fire if the installation is not performed correctly.
- ⚠ During the installation, it is necessary to observe the precautions mentioned in this manual, and on the labels placed inside the equipment, as well as to adopt any precaution suggested by common sense and by the Safety Regulations in force in the place of installation.
- ⚠ Be sure to use the supplied or specified installation parts. Use of other parts may cause the unit to come loose, leak water, or cause electrical shock, or fire.
- ⚠ The Manufacturer accepts no liability for damage caused to animals or property due to failure to apply the indicated rules which may cause malfunction of appliances.

4.2 Reception

4.2.1 Preliminary warnings

- ⚠ On receipt check for any damage and, if any is found, accept the goods with reservation, and keep photographic evidence of any damage found
- ⚠ In the event of damage, notify the shipper within 3 days of receipt of any damage by registered mail with return receipt, submitting photographic evidence. Similar information should be sent by fax to the manufacturer (jurisdiction will be at the Court Trento for any dispute).
- ⚠ No notice of damage will be accepted after 3 days from delivery.

- ⚠ Unpack and check the contents of individual components against the packing list.

4.2.2 Package description

The packaging is made of suitable material and carried out by experienced personnel.
All units are checked and tested and are delivered complete and in perfect condition.
The appliance is shipped in standard packaging consisting of a cardboard sleeve and a set of expanded polystyrene protectors.

4.3 Dimensions and weights with packaging

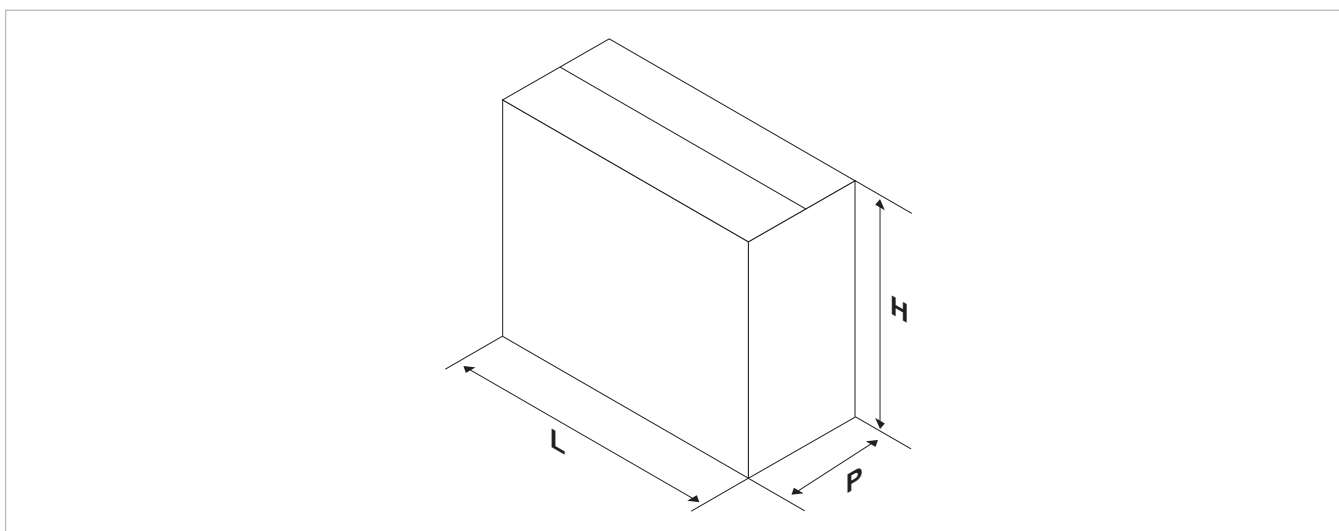

		P-FMM**
Models	u.m.	40
Dimensions and weight for shipping		
Width	mm	1420
Height	mm	450
Total depth	mm	320
Weight	kg	25,0

4.4 Handling with packaging

4.4.1 Preliminary warnings

- ⚠ The appliance must be handled only by qualified personnel, adequately equipped and with equipment suitable for the weight and dimensions of the appliance.
- ⚠ Stay clear of the area below and around it when the load is lifted off the ground.
- ⚠ Avoid dangerous situations when using a hoist to lift the appliance.
- ⚠ During transportation, the unit must be kept in vertical position.

4.4.2 Movement methods

Boxes can either be carried singularly by hand by two operators or loaded on a forklift truck evenly stacked.

- ⚠ Check the indications on the packaging for the number of packages that may be stacked together.

- ⚠ In manual operation it is compulsory to always respect the maximum weight per person provided for by the national laws and standards.
- ⚠ Use the handles provided on the packaging.

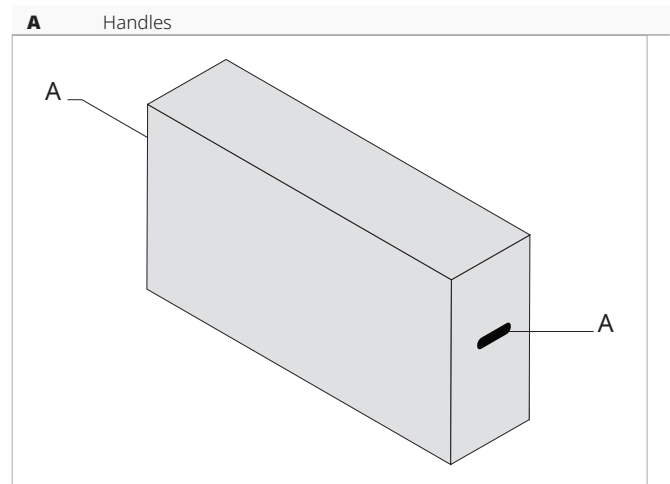

4.5 Storage

4.5.1 Preliminary warnings

- ⚠ Store in accordance with the applicable national regulations.
- ⚠ Store the box in a closed environment protected from atmospheric agents and isolate it from the floor using planks or pallets.

- ⚠ Do not turn the packaging upside down.
- ⚠ Only place the appliance in a vertical position.
- ⚠ Store in a clean and dry place.

4.6 Unpacking

4.6.1 Preliminary warnings

- ⚠ Check that no components were damaged during transport.
- ⚠ Dispose of the packaging components following the applicable waste disposal regulations. Check for disposal arrangements with your municipality.

- ⚠ Handle with care.
- ⚠ The equipment must always be handled vertically.
- ⚠ Check if there is refrigerant inside the package using an electronic leak detector suitable for the system refrigerant. If it is present, the refrigeration circuit is likely damaged. In this case, do not install the appliance and call the Authorised Service Centre.

- ⊖ The packing material (cardboard, staples, plastic bags, etc.) must not be dispersed or abandoned in the surrounding environment and must be kept out of the reach of children, as it poses a risk of danger.

4.6.2 Remove the package

1. Polystyrene elements

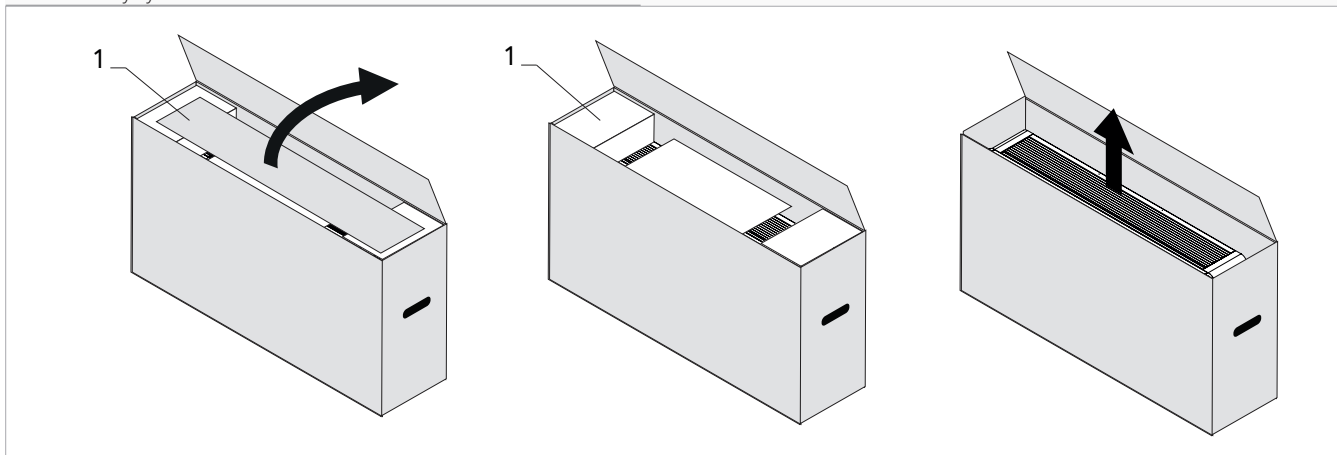

Remove the packing:

- ▶ open the cardboard packaging
- ▶ remove the polystyrene elements

- ▶ remove the accompanying components
- ▶ remove the appliance from the box

Accompanying material

They are included with the appliance, inside the packaging:

- 1 instruction sheet for downloading the manuals
- 1 label for scanning the QR Code

- 1 installation template
- 2 wall mounting brackets

⚠ Check the presence of the individual components.

4.7 Handling without packaging

4.7.1 Preliminary warnings

- ⚠ The appliance must be handled only by qualified personnel, adequately equipped and with equipment suitable for the weight and dimensions of the appliance.

4.7.2 Movement methods

- ⚠ The unit can be moved manually for short distances. In this case it is necessary to check carefully that the weight of the unit does not exceed the regulations in relation to the number of people used.

4.8 Installation site

Position of device must be established by the system designer or other qualified professional and must take into account both technical requirements and any local codes.

The Aquarea Air - Wall Mounted fancoil has to be installed only in high position on the wall, with a maximum height of 2,2 m (except for use in Cooling only).

4.8.1 Preliminary warnings

- ⚠ Avoid installing the unit near:
 - obstacles or barriers that cause recirculation of the exhaust air
 - narrow places where the sound level of the appliance can be enhanced by reverberations or resonances

- environments with the presence of flammable or explosive gases
- very humid environments (laundries, greenhouses, etc.)
- environments with aggressive atmospheres
- solar radiation and proximity to heat sources
- rooms subject to high frequencies

⚠ Do not install over heat sources.

- ⚠ Make sure that:
 - the installation site of the unit must be chosen with the utmost care to guarantee adequate protection from shocks and consequent damage
 - the supporting structure is able to support the weight of the appliance

- the supporting structure section does not feature building supporting elements, pipes or power lines
- the supporting surface is perfectly levelled
- there are no obstacles to the free circulation of air
- the appliance must be installed in a position where it can be easily serviced
- the safety distances between the units and other appliances or structures are scrupulously respected so that the air entering and leaving the fans is free to circulate

- ⚠ If the appliance is installed incompletely or on an inappropriate base, it could cause damage to persons or property if it should detach from its base.
- ⚠ The unit should not be installed in a position where the air flow is aimed directly at the people nearby.
- ⚠ Provide the following:
 - a nearby drain for the outflow of condensate
 - a compliant power supply nearby
 - fixing elements suitable for the type of support

4.9 Installation mode

The assembly steps described below and their drawings refer to a version of the machine with connections on the right side.

- ⚠ For ideal installation and performance levels, carefully follow the instructions in the manual.

- ⚠ Failure to do so may cause system malfunctions and automatically voids the warranty, and relieves the manufacturer of any harm caused to person, animals or property.

4.10 Installation minimum distances

The clearance zones for the installation and maintenance of the appliance are shown in the figure. Established spaces are necessary to avoid barriers to airflow and allow for normal cleaning and maintenance.

- ⚠ Make sure that there is sufficient space to allow the panels to be removed for routine and supplementary maintenance operations.

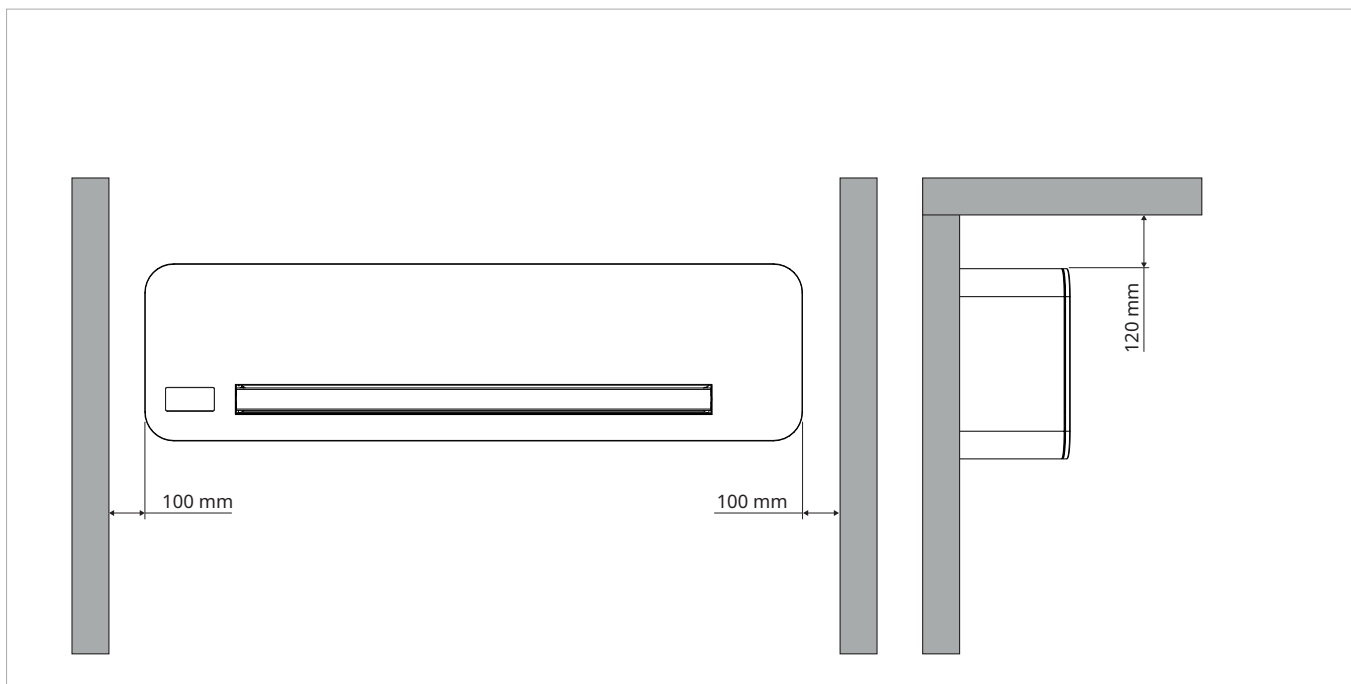

4.11 Positioning

The Aquarea Air - Wall Mounted fancoil has to be installed only in high position on the wall, with a maximum height of 2,2 m (except for use in cooling only). The units are supplied with a paper template for marking the holes necessary for installation Aquarea Air - Wall Mounted.

4.11.1 Preliminary warnings

- ⚠ The unit requires two or more people to position the unit.
- ⚠ Make sure that:
 - the wall supports the weight of the appliance
 - the section of the wall does not contain piping or electrical lines

- the functionality of load-bearing elements is not compromised

4.11.2 Device preparation

Before proceeding with the installation, it is necessary to remove some elements from the appliance.

Remove the filter

1. Air intake filter

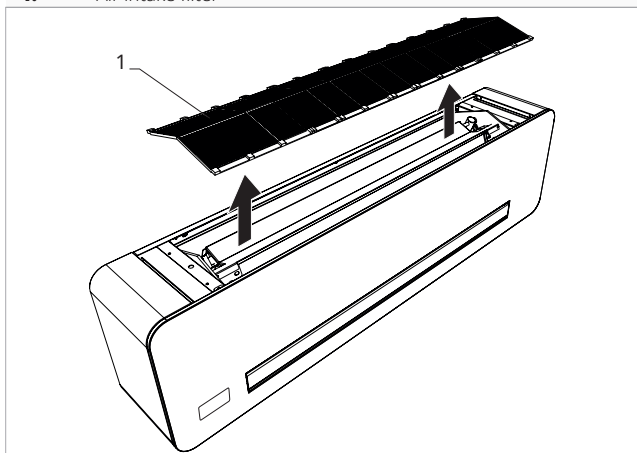

- ▶ lift the filter slightly
- ▶ rotate until the complete exit from the housing
- ▶ remove the filter

Removal of the aesthetic front panel

1. Fixing screws
2. Screw fixing bracket
3. Aesthetic front panel

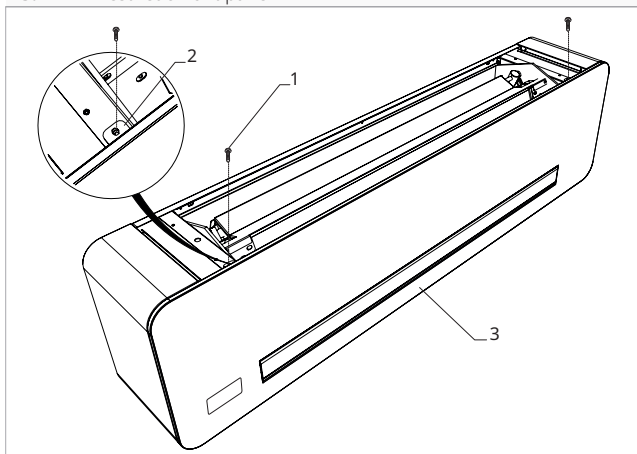

- ▶ unscrew the fixing screws

1. Aesthetic front panel

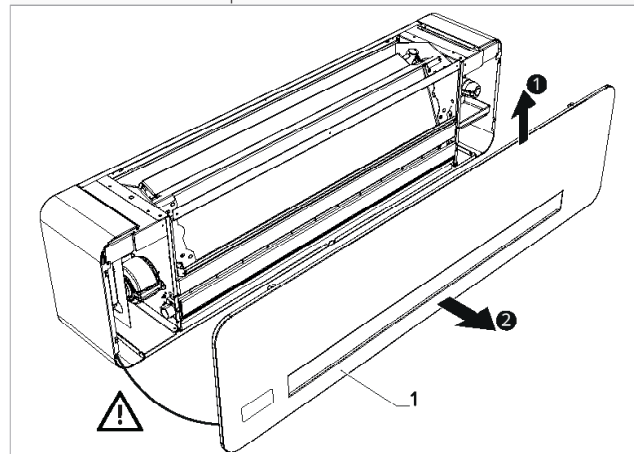

- ▶ remove the aesthetic front panel
- ▶ remove the screws on the touchpad support metal plate (if present)
- ▶ Disconnect the display connection cable

Remove the side panels

1. Fixing screws
2. Aesthetic sides

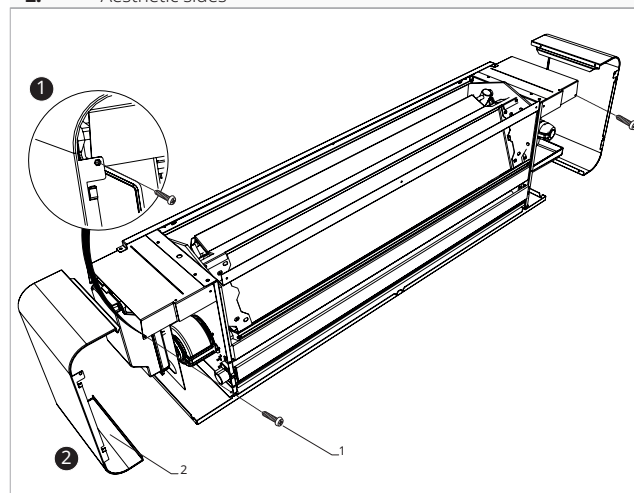

- ▶ unscrew the fixing screws
- ▶ remove the side panels

4.11.3 Installation arrangement

To install the appliance, use a recessed box to contain the connections.

- ⚠ If the appliance is not installed immediately, make sure to leave enough pipe length to avoid making joints when installing it.

- 1. Built-in cabinet
- 2. Connecting water pipelines
- 3. Condensation drainage pipe

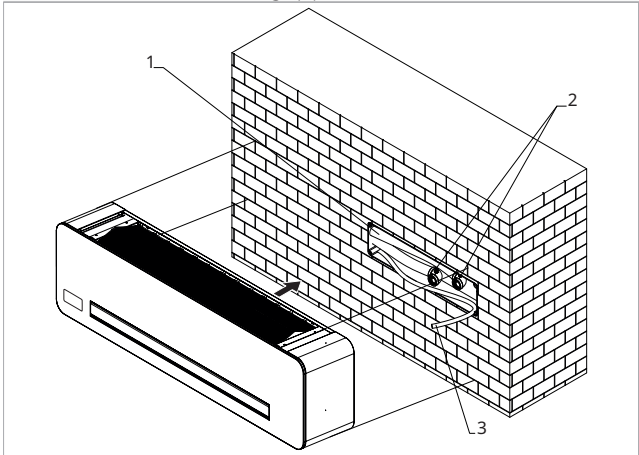

4.11.4 Positioning

! The units are supplied with a paper template for marking the holes necessary for installation.

- 1. Minimum distance to the ceiling
- 2. Holes for dowels, \varnothing 8 mm
- 3. Electrical connection area for installation on the right
- 4. Lower perimeter of the unit
- 5. Pipe inlet area - provide flush-mounted box for hydraulic hose connection
- 6. Outlet for installation with 2-way valve
- 7. Outlet for installation with 3-way valve
- 8. Inlet for installation with 2-way valve
- 9. Inlet for installation with 3-way valve
- 10. Condensate drain for hydraulic connections on the right
- 11. Top perimeter of the unit

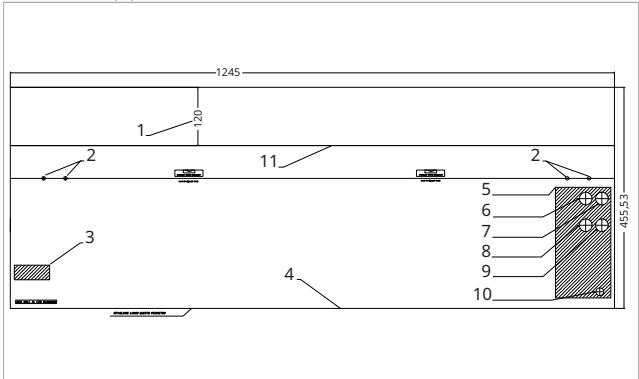

- ▶ use the paper template supplied with the device
- ▶ trace the position of the fixing brackets
- ▶ drill holes in the wall

- !** Hold the template in the correct position with tape.
- !** Make sure that the support wall is suitable for weight of the appliance.
- !** Make sure that the wall is not crossed by pipelines, load-bearing construction elements or power lines.

- A Plugs
- B Brackets

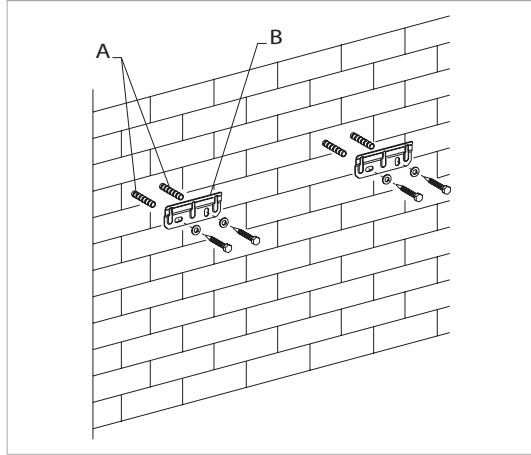

- ▶ insert the expansion anchors
- ▶ position the support brackets
- ▶ partially secure the screws

! Do not fully secure the screws so that you can adjust the position of the appliance.

! Use anchors suitable for the chosen supporting structure.

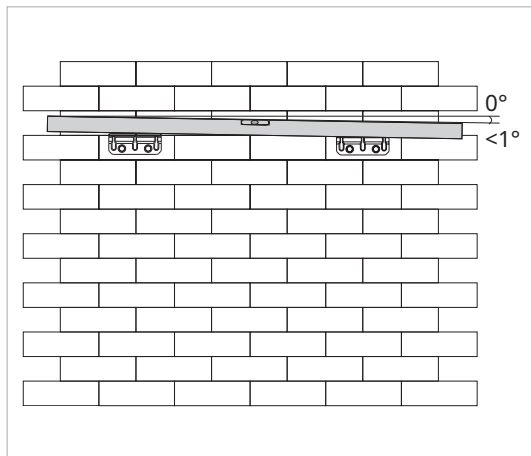

- ▶ use a level
- ▶ check the inclination towards the attachment side
- ▶ secure the screws

! A maximum inclination of 1° towards the right side of the appliance is allowed to facilitate the drainage of condensate.

1. Fixing bracket

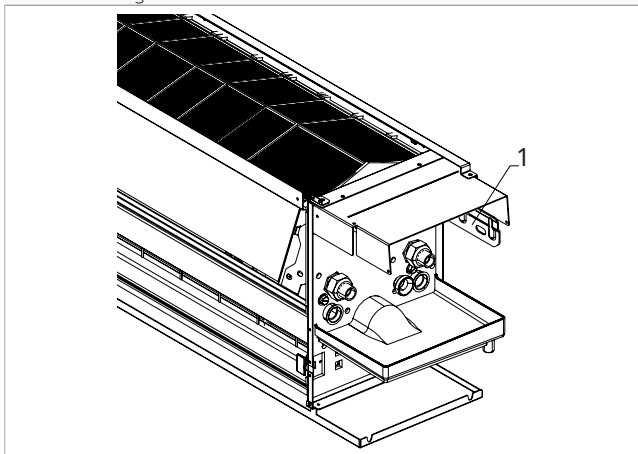

- ▶ assemble the unit
- ▶ check right attachment to the bracket

4.12 Hydraulic connections

The installer is responsible for choosing the right water lines and their size, in accordance with good installation practices and the applicable codes.

4.12.1 Preliminary warnings

⚠ Keep in mind that undersized pipelines lead to poor system operation and/or a loss of thermal and cooling performance.

⚠ The installer is responsible for choosing the right water lines and their size, in accordance with good installation practices and the applicable codes.

⚠ The hydraulic system is made by the installer and must be carried out with reference to the diagrams in this manual or on the website.

⚠ The hydraulic pipes connecting to the appliance must be suitably sized for the actual water flow rate required by the plant during operation. The water flow rate to the heat exchanger must always be constant.

4.12.2 Position and dimensions

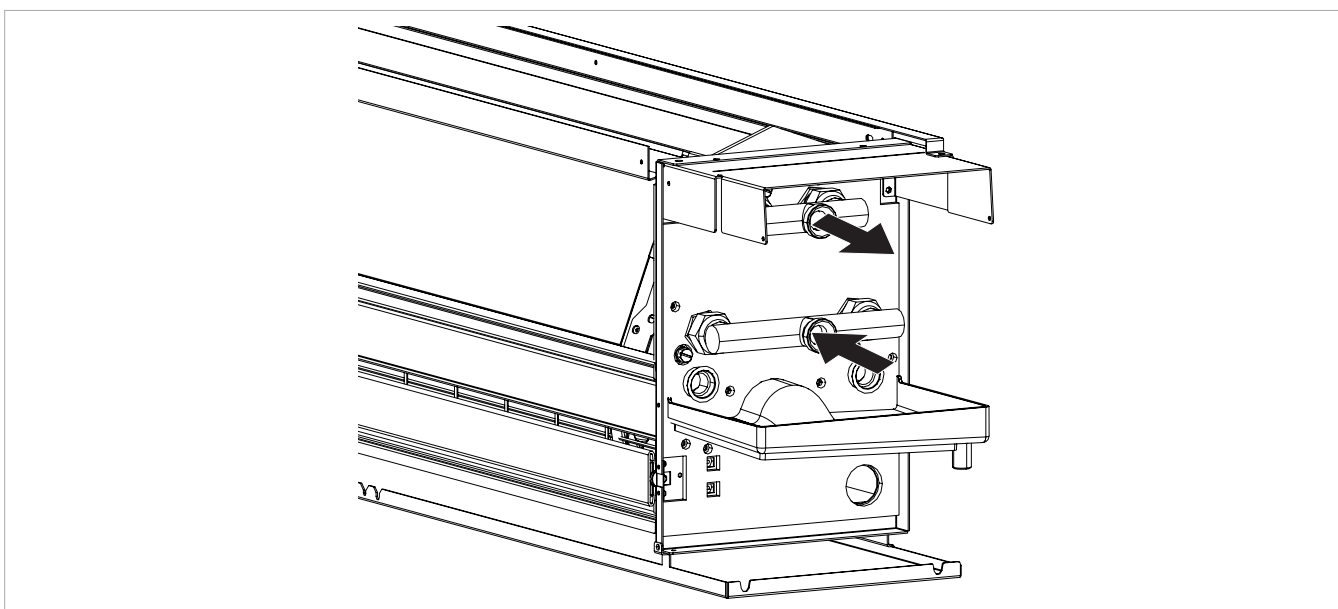

		P-FMM**
Models	u.m.	40
Hydraulic data		
Pipeline diameter	mm	18

⚠ For dimensional information, refer to chapter "Technical information" p. 54.

4.12.3 Connection to the system

To make the connections:

- ▶ hydraulic lines positioning
- ▶ use the "double wrench" method
- ▶ tighten the connections
- ▶ check for leaks
- ▶ coat the connections with insulating material

- ⚠ The hydraulic lines and fittings must be thermally insulated.
- ⚠ Avoid partial insulation of the pipes.
- ⚠ Avoid over-tightening the tape to avoid damaging the insulation.
- ⚠ Carefully check that the insulation is tight, in order to prevent the making and dripping of condensate.

4.13 Condensation drain preparation

This appliance is complete with a tray for collecting the condensation produced during operation, which must be channelled to a suitable place for drainage. The size and positioning of the drainage tube are shown below.

- ⚠ **Check the installation template for correct position of the condensate drain pipe inlet on the wall. See chapter "Installation template" p. 56.**

1. Condensate drain connection

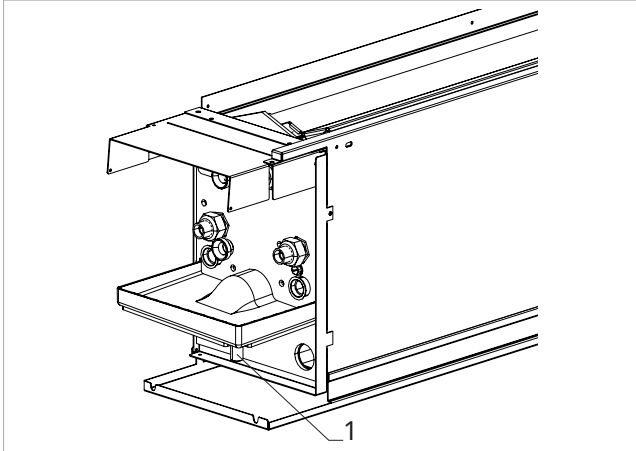

		P-FMM**
Models	u.m.	40
Product dimensions and weight		
Condensate drain connection	mm	14

4.13.1 Preliminary warnings

- ⚠ If the line flows into a container (e.g. a tank), do not close the container hermetically and avoid immersing the draining pipe into the water.
- ⚠ The hole for the condensation pipe must always slope towards the outside.
- ⚠ The exact position in which to place the pipe mouth is indicated on the template.

4.12.4 Shut-off valves

As standard, the unit is supplied without shut-off valves. In other case, depending of the request, the unit can be supplied with valves already assembled or supplied separately to be mounted during installation.

- ⚠ The 2-way and 3-way motorized valves are mandatory for the correct operation of the unit.
- ⚠ The motorized valve can be omitted, inside the unit, if there is a motorized valve in the distribution manifold of the system and connected to the regulation card of the unit.
- ⚠ 2-way or 3-way motorized valves are available as accessories, see chapter "Compatible accessories" p. 10.
- ⚠ For detailed information on accessories please refer to the "Configuration accessories" p. 52 section.

- ⚠ Check that the expelled water does not cause any damage or problems to people or objects. During winter, this water may create sheets of ice outside.
- ⚠ When connecting the condensation drain, be careful not to squeeze the rubber duct.
- ⚠ If you do not want to prepare an external drainage pipe in "heat only" mode, it is advisable to close the condensate drain with a plug.

4.13.2 Positioning

- ⚠ To connect the condensate drain connection to the drainage pipe, a connection stub with a pipe length of 33.7 mm is required.

1. Condensate drain connection
2. Connecting stub

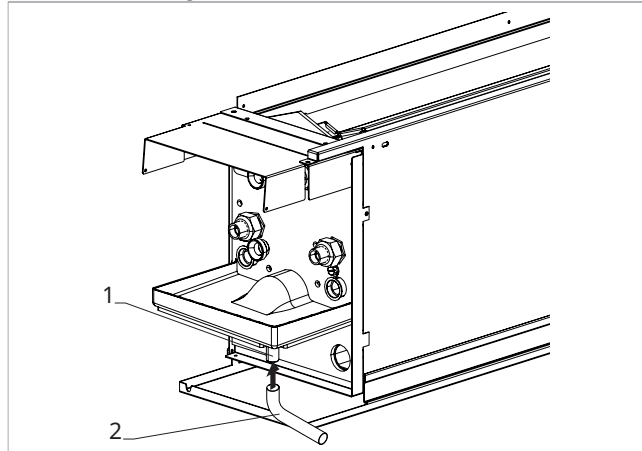

- ▶ connect a rubber drainage tube
- ▶ direct it to a suitable place for dropping
- ▶ connect the connection stub to the condensate drain connection

1. Drainage tube
2. Connecting stub

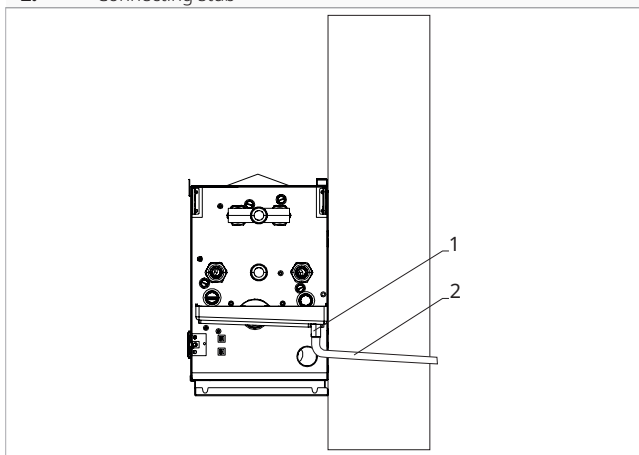

- ▶ connect the drains to the connection stub
- ▶ provide a slope never less than 1%
- ▶ insulate fitting points

- ⚠ Pay attention to the angle of the condensate drain pipe.
- ⚠ Use plastic drainage pipes.
- ⚠ Avoid pipes made of metallic material.
- ⚠ Make sure all joints are sealed to prevent leakage of water.
- ⚠ Condensate drainage pipes must be insulated for both indoor and outdoor sections of the house to avoid condensation on the surface and/or freezing problems.

4.14 Filling the system

To fill the system:

- ▶ open the vent valves
- ▶ open all the system's shut-off devices
- ▶ slowly introduce the water supply

When water begins to leak out of the vent valves:

- ▶ close the vent valves
- ▶ complete system filling
- ▶ verify that you have reached the nominal pressure for the system
- ▶ isolate the water supply
- ▶ check the tightness of the gaskets

- ⚠ It is recommended to repeat this operation after the device has been running for a few hours.
- ⚠ Regularly check the system's pressure.

If using a tank for collecting the condensation:

- ⚠ Avoid the hermetic closure of the container.
- ⚠ Prevent the end of the drainage tube from falling below the water level.

If draining into the sewage system:

- ⚠ Make a trap to prevent bad smells returning up the pipe towards the room. The curve of the siphon must be lower than the condensation collection pan.
- ⚠ The trap must feature a plug in its lower part or must otherwise allow for quick disassembly for cleaning purposes.
- ⚠ Install a pump if the drain pipe is higher than lower level of the collection pan.

If using an open drain:

- ⚠ Make the condensate liquid flow directly onto a gutter or into a "grey water" drain
- ⚠ If the condensation is not collected, it will be deposited on the support surface. The water could freeze if the outdoor temperatures are below zero, thus creating a hazard. In this case, appropriate barriers should be installed in order to prevent people from approaching the area.

4.13.3 Check

After the installation is completed:

- ▶ pour water very slowly into the condensate drain pan
- ▶ check for correct condensate drainage

1. Air vent

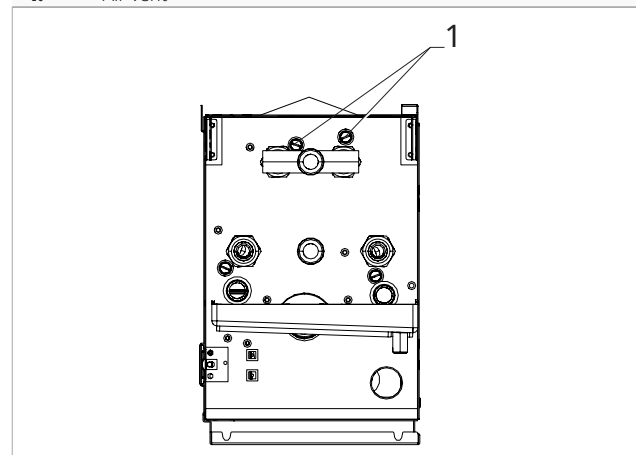

4.14.1 Mounting the electrical actuator

To mount the electrical actuator:

- ▶ tighten the head to the valve body

To facilitate the system mounting, filling and venting operations, even without electric power, the electrical actuator is supplied with a tool that keeps it open.

- ⚠ Remove the tool from the thermostatic head before starting the system.

1. Electrical actuator
2. Valve body
3. red plastic tool

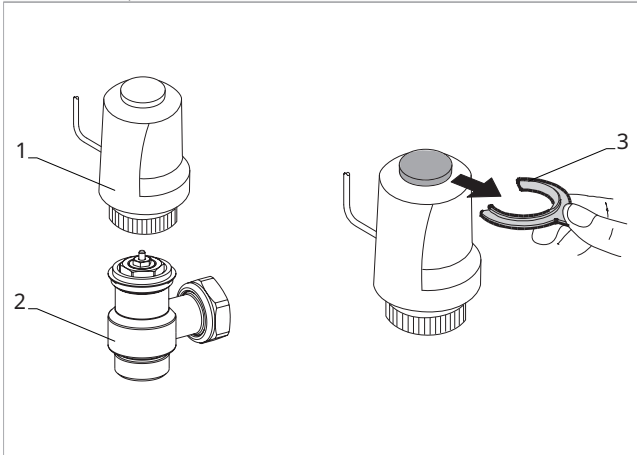

4.15 Electric connections

The device leaves the factory fully wired and needs only the connection to the power supply, to any controls and accessories.

4.15.1 Preliminary warnings

- ⚠ All operations of an electrical nature must be carried out by qualified personnel having the necessary training, who understands the legal requirements, and is informed about the risks related to such operations.
- ⚠ All connections must be made following the regulations in force in the country of installation.
- ⚠ Before carrying out any work, make sure that the power supply is switched off.
- ⚠ The unit must only be powered after all plumbing and electrical work has been completed.
- ⚠ References:
 - refer to the wiring diagrams in this manual for the electrical connections, especially the part concerning the power supply terminal block

Make sure that:

- the characteristics of the electric network are adapted to the absorption of the apparatus, considering also any other devices in parallel operation
- the power supply voltage and system frequency match to the values indicated on the device's plate data
- the cables must be appropriate for the type of installation in accordance with the IEC applicable standards
- the power supply is provided with protection against overload and/or short-circuit
- the disconnection device is located in an easily accessible place in order to be able to intervene in the event of an emergency

4.15.2 Power line dimensioning

For the size of the power supply cable and safety devices, use the following table.

It is required:

- provide a suitable grounding connection
- provide an all-pole switch with a contact opening distance of 3 mm or more that allows complete disconnection under overvoltage category III conditions
- ⚠ Use a dedicated power supply circuit. Never use a power supply to which another appliance is also connected because of the risk of overheating, electric shock or fire.
- ⚠ The device is equipped with suppression filter as laid down by the applicable codes and standards. Use selective circuit breakers to compensate for the micro-dispersion on the grounding of this device.
- ⚠ For the electrical connection, use a cable that is long enough to cover the entire distance without any connection. Do not use extension cables. Do not apply other loads on the power supply.
- ⚠ After connecting the interconnection and power cables, make sure that the cables are routed so that they do not apply excessive forces on the covers or electrical panels. Incomplete connection of the covers may result in overheating of the terminals, electric shock or fire.
- ⊖ It is forbidden to use gas and water pipes for grounding.
- ⚠ Any replacement of the power cable must be carried out by authorised personnel and in accordance with the applicable national codes.
- ⚠ The Manufacturer is not liable for any damage caused by the lack of earthing or failure to comply with the specifications in the respective diagrams.
- ⚠ Disconnect the main circuit breaker before making any electrical connections and performing maintenance on the equipment.

Models	u.m.	P-FMM**
		40
Electrical data		
Power conductor (phase+neutral)	mm ²	1,5
Protective conductor section on ground	mm ²	1,5
Circuit breaker	A	2

⚠ The values indicated refer to a maximum line length of 15 m.

4.15.3 Access to the terminal block

To connect the power supply:

1. Fixing screws
2. Terminal block for wiring

3. Cover of the electrical box

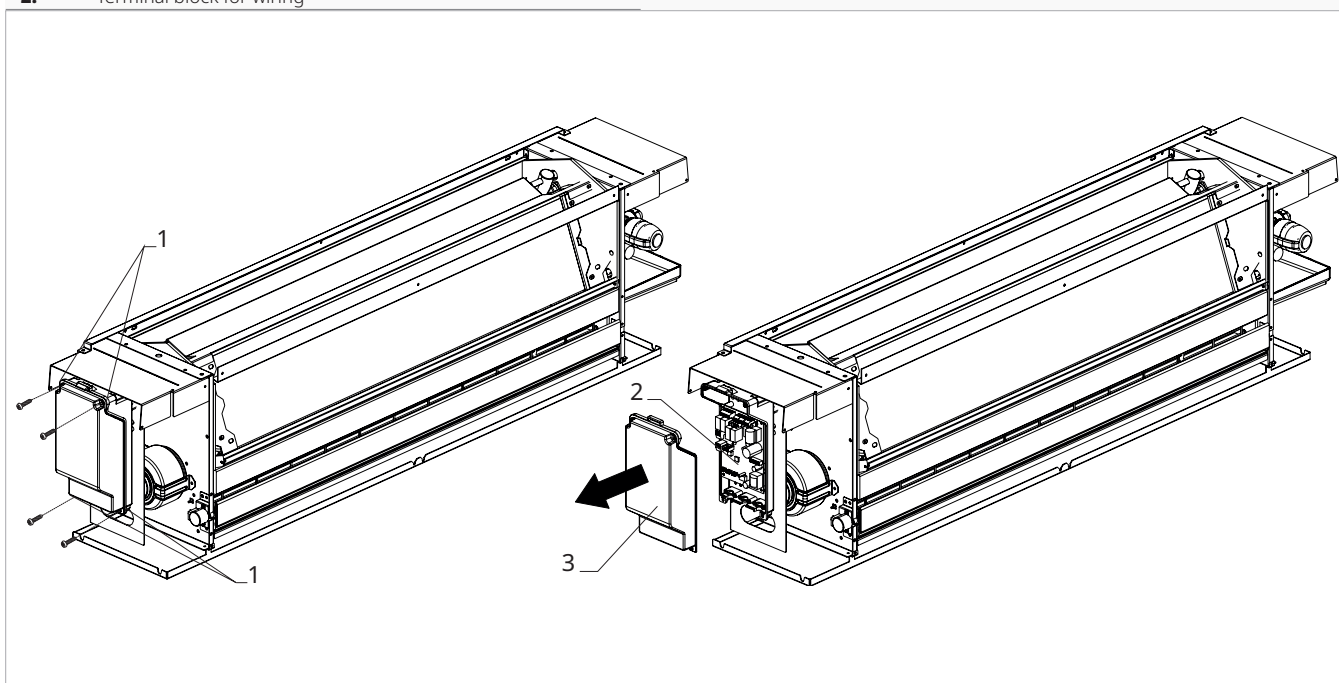

⚠ Before carrying out any work, please ensure the power supply is disconnected.

⚠ Access to the electrical panel is only permitted to qualified personnel.

To access:

- ▶ remove the aesthetic front panel and side panels

To access the connections:

- ▶ unscrew the fixing screws of the electric box
- ▶ remove the panel

To make the connection:

- ▶ bring the power cord to the terminal block
- ▶ making the connections

⚠ Refer to the information in the wiring diagram of the unit you are installing.

⚠ The electrical connection can be made by means of a cable installed in a flush-mounted duct in the wall (see position indicated on the template). This connection is recommended for installations of the appliance at the top of the wall.

⚠ It is necessary to check that the power supply is provided with appropriate protection against electric shorts and/or overloads

4.15.4 Electrical connection and settings

⚠ Refer to the respective section of the control, used to make the electrical connections.

Touchpad and remote control. (See section "Touchpad and remote control" *p. 22*)

Remote controls for wall-mounted control Cod. PCZ-EEB749 (See section "Wall-mounted control Coding PCZ-EEB749" *p. 27*)

Remote controls for Wi-Fi module wall control Cod. PCZ-EFB749 (see section "Wall-mounted control Coding PCZ-EFB749" *p. 37*)

0-10 V connection. (See section "0-10 V connection" *p. 47*)

5. TOUCHPAD AND REMOTE CONTROL

5.1 Interface

The touchpad control is supplied as standard on board the unit, does not require any connections and enables:

- show the operating status

- show any alarms
- select the various functions

1. Display area
2. Keys area

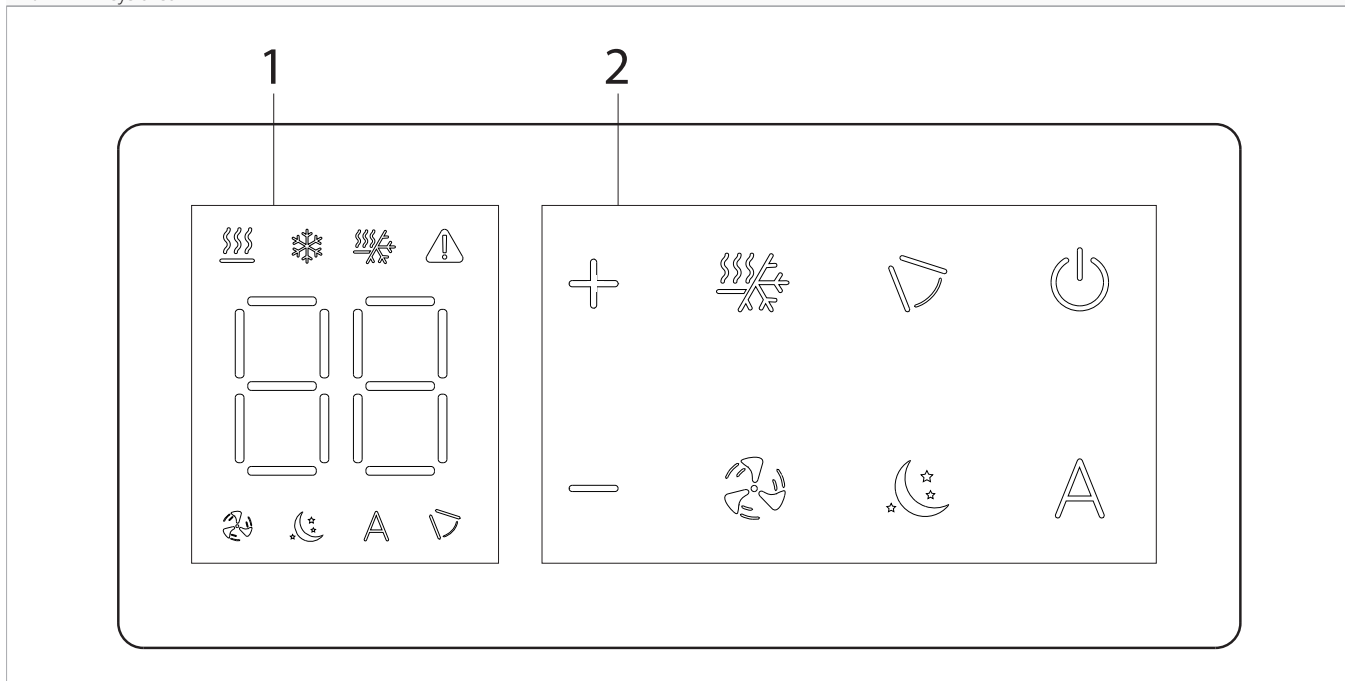

5.1.1 Description

On-board control, with continuously modulating thermostat.

5.2 PCB

The PCB is included in the supply.

M1	DC fan motor
	Ground connection
230~50	Power supply connection 230 V / 50 Hz
Y1	Water solenoid valve (230 V / 50 Hz / 1 A power output)
CH/C1	Cooling request contact (for example chiller or reversible heat pump). Activated in parallel with the solenoid valve output (Y1) with 1 minute delay when the fancoil is in cooling mode and is on call (potential-free contact max. 1 A).
BO/C2	Heating request contact (for example boiler or heat pump). Activated in parallel with the output of the solenoid valve (Y1)

	with 1 minute delay when the fancoil is in heating mode and is on call (potential-free contact max. 1 A).
CP	Presence contact (normally open)
SM	Step Motor
IN1	Input for potential-free contact 1
AIR/T1	Air temperature probe
H2/T2	Water temperature probe
DU	Touchpad
PU	Electronic board on the unit
PSM	Electronic board for step motor connection

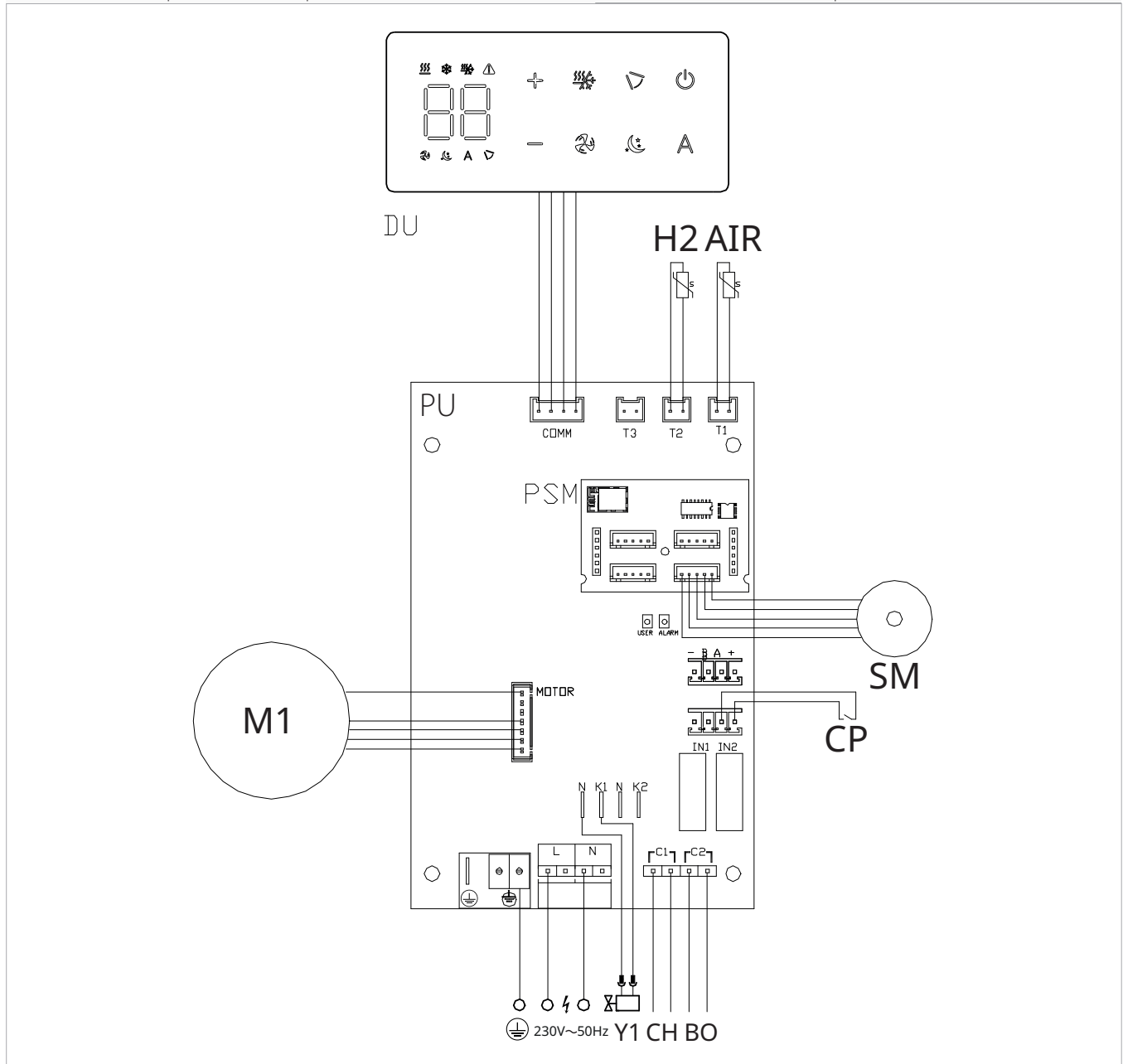

Through the water temperature probe H2/T2 (10 kΩ) located in the thermowell on the unit's coil, the temperature setpoints for fan stop are controlled:

- minimum temperature in heating mode (30 °C)
- maximum temperature in cooling mode (20 °C)

⚠ The printed circuit board provides for operation without a water probe. In this case, the fan stop thresholds are ignored.

5.3 Connections

5.3.1 Presence contact CP

Through this device it is possible to connect an external control signal that inhibits the operation of the control signal, for example:

- opening window contact
- remote on/off
- infrared presence sensor
- activation badge

Function

The contact is normally open (NO).

- ▶ when closing the CP contact, connected to a potential-free contact, the device switches to stand-by mode
CP appears on the display.

- ▶ At the touch of a button on the display the symbol  flashes.

- ⊖ It is forbidden to connect the CP input to that of another unit electronic board. Use separate contacts.

The CP presence contact can be configured for heating and cooling operation via the "To select digital input" *p. 25* settings menu item (digital input).

5.4 Functions



- ⚠ The keys of the remote control and touch-screen display perform the same function.

5.4.1 Basic menu

To access the basic menu



- ▶ with the display off, hold down  for 10 seconds

The device turns on and  appears

- ▶ keep pressed until the indication  appears
- ▶ release the  key

The symbol  appears

To navigate in the menu

- ▶ use the icons  





To select a menu item and to confirm the changes made

- ▶ press the icon 
Confirming the change takes you to the next item.

To exit the menu



- ▶ press the icon  for 10 seconds
- ▶ or wait 30 seconds after the last action
The display is switched off automatically.

To set the air probe offset

- ▶ select 
- ▶ press  to change settings
- ▶ increase or decrease the value with the icons  
- ▶ press  to confirm
*By default it is set to 0.
The range of settings is from a minimum of -9°C to a maximum of +9°C.*

Scale

To change the temperature unit of measure

- ▶ select 
- ▶ press  to change settings
- ▶ select °C or °F
- ▶ press  to confirm
By default the temperature unit of measure is °C.

Menu items

ot: AIR probe offset (air probe setting)

CF: Scale

ub: Buzzer volume

uu: Not used

up: Not used





ho: Hotel Mode

Set AIR probe offset

- ⚠ The set value changes by 1 °C each press of the  and  buttons.

Adjusting buzzer volume

To change the volume

- ▶ select 
- ▶ press  to change settings
- ▶ increase or decrease the value with the icons  
- ▶ press  to confirm
The volume setting range is from 00 (min) to 03 (max).

- ⚠ The volume changes after confirming the modification.

Setting the Hotel Mode

To set the Hotel mode

- ▶ select 
- ▶ select YS to turn on Hotel mode
- ▶ select NO to turn off the Hotel mode
By default the device is set to NO.

Activating the Hotel mode:

- the Autochangeover function is deactivated





- the temperature setting range is reduced, in Cooling you can set from 22 °C to 28 °C, in Heating you can set from 16 °C to 24 °C

5.4.2 Advanced Menu



⚠ To access the setup menu, it is necessary to access the Basic menu. See section "Basic menu" p. 24.

The special functions menu can be accessed via the control panel.

To access the advanced menu

- ▶ from the basic menu press 
 - Appears 
- ▶ press the  key once
 - Appears 
- ▶ press  to confirm and log in
 - This takes you to the settings menu.



To navigate in the menu

- ▶ use the icons  

To select a menu item and to confirm the changes made

- ▶ press  for 2 seconds
 - Confirming the change takes you to the next item.

To exit the menu

- ▶ press  for about 10 seconds
 - Appears 
- ▶ press  for about 10 seconds
 - The display turns off.
- ▶ or wait 30 seconds after the last action
 - The display is switched off automatically.

⚠ After 30 seconds from the last action the control returns to the start screen and the last chosen values are recorded.

Menu items

Ad: Not used

di: Options for digital input

UC: Not used



Ac: Anti-stratification in cooling

Ah: Anti-stratification in heating

Fr: Not used

To select digital input

To change the digital input







- ▶ select 
- ▶ press  to change settings
- ▶ select CP for presence contact (default)
- ▶ select CO to cooling open
- ▶ select CC to cooling close
- ▶ press  to confirm
 - By default digital input is set to CP.

⚠ For return to the default settings, set the digital input to "CP".

⚠ By selecting one of the other inputs (CO,CC) the seasonality is locked. It is not possible to modify it through the key  of the control.

Set the anti-stratification function to cooling







To set the anti-stratification function in cooling mode

- ▶ select 
- ▶ press  to change settings
 - Appears 
- ▶ press  to move within the menu
- ▶ select  to enable the function
- ▶ press  to confirm changes
 - By default, the anti-stratification function in cooling is set to 

⚠ The anti-stratification function in cooling is to be set for appliances installed at low floor level equipped with an active air probe.

Set the anti-stratification function in heating mode

To set the anti-stratification function in heating mode

- ▶ select 
- ▶ press  to change settings
 - Appears 
- ▶ press  to move within the menu
- ▶ select  to enable the function
- ▶ press  to confirm changes
 - By default, the anti-stratification function in heating is set to 

⚠ The anti-stratification function in heating is to be set for appliances installed high up on the wall or ceiling equipped with an active air sensor.

5.4.3 Error signals

The PCB has a status LED.

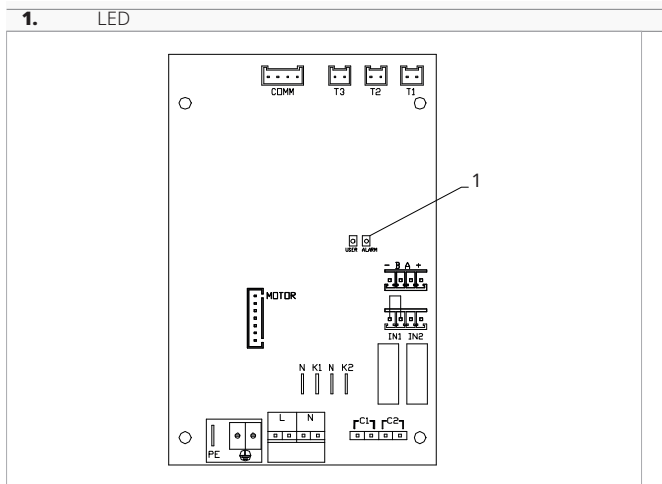

- ⚠ The flashing LED indicates errors.
- ⚠ It is possible to verify the meaning of the LEDs by means of the error code displayed on the touchpad.
- ⚠ To identify the error, please refer to "Visualization of alarms on display" p. 26.
- ⚠ With the LED on and no indication on the display, it is indicated that there are no errors.

5.4.4 Visualization of alarms on display

- ⚠ In the event of a malfunction, the display shows an alarm code.
- ⚠ In the event of an alarm, the device still maintains active functions.

- ▶ E1 Air temperature probe alarm T1 on PUB-30 board disconnected or with incorrect values (-10÷40)
The device is operating and the M7 control uses its own air probe.
 - ▶ E2 Internal fan motor faulty or disconnected
None of the modes can be activated.
 - ▶ E3 Water temperature sensor H2/T2 disconnected or faulty
None of the modes can be activated.
 - ▶ CE Communication error
Errors in the communication between the touchpad control and the board. None of the modes can be activated.
The symbol ⚠ appears to indicate unsuitable radiant water.
 - ▶ 🌊* Incorrect water temperature
In heating mode, the water temperature is below 30 °C
 - ▶ ❄* Incorrect water temperature
In cooling mode, the water temperature is above 20 °C.
- * flashing

6. WALL-MOUNTED CONTROL CODING PCZ-EEB749

6.1 Interface

1. Display area
2. Keys area

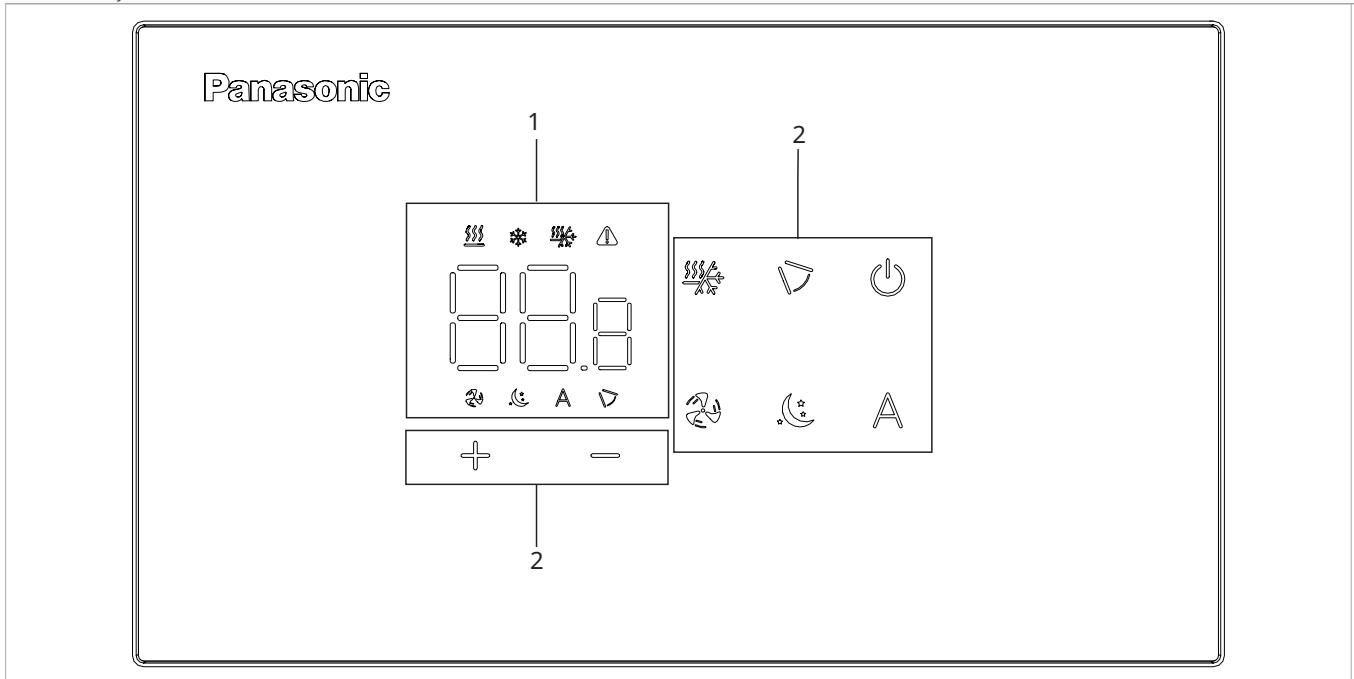

6.2 Installation

6.2.1 Description

The wall-mounted remote control is an electronic LED thermostat with a touch interface, with the possibility of controlling multiple appliances equipped with the same electronic board. It is equipped with a temperature and humidity probe.

⚠ The control can manage a maximum of 16 units.

6.2.2 Mounting

⚠ The control panel must be mounted in an electrical back box.

⚠ A wall must be prepared to accommodate the electrical box before installing the wall control.

⚠ Ensure that:

- the wall supports the weight of the appliance
- the section of the wall does not contain piping or electrical lines
- the functionality of load-bearing elements is not compromised

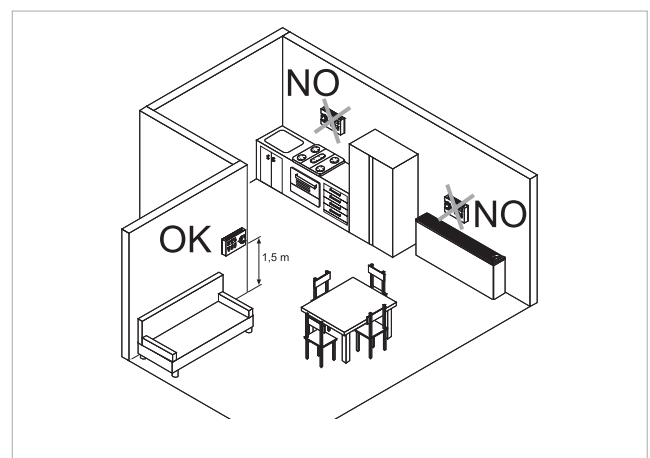

The wall-mounted remote control must be installed:

- on internal walls
- at a height of about 1,5 m from the floor

⚠ Should the control be located in an area utilised by persons with reduced physical capabilities, please refer to local regulations.

- away from doors or windows

- away from heat sources (heaters, convectors, stoves, direct sunlight)

⚠ The wall control is provided inside the package already assembled.

- | | |
|----|----------------------------|
| 1. | Back plate |
| 2. | Wall-mounted control panel |

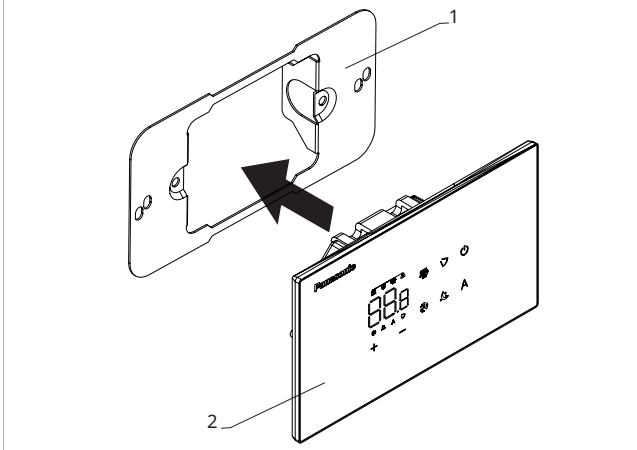

Before wall installation:

- ▶ separate the back plate from the control panel

- | | |
|----|------------------------------------|
| 1. | Fixing screws |
| 2. | Back plate |
| 3. | Holes for fixing to electrical box |
| 4. | Electrical back box |

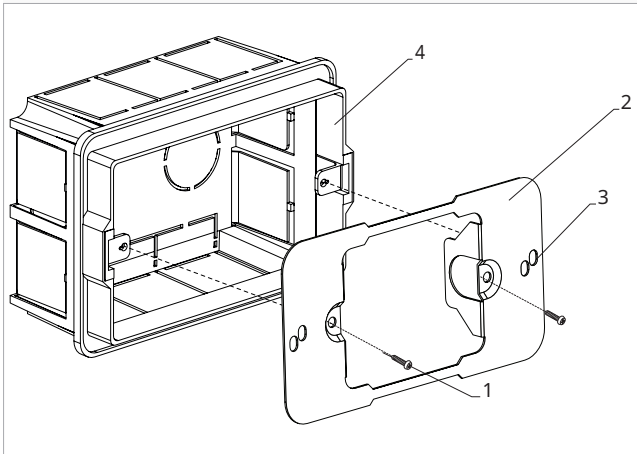

For wall mounting of the control panel:

- ▶ fix the back plate to the electrical back box with screws
- ▶ connect the electrical wiring

⚠ Ensure that the air probe sensor is not affected by air currents, whether warm or cold, coming from the recessed wall box.

⚠ To avoid interference in temperature measurement:

- seal the cable-entry conduits tightly so that they do not allow air to pass through.
- seal any openings in the box or the wall that could connect the back of the thermostat with the air circulating in the wall cavities

⚠ proper sealing ensures the correct operation of the sensor and the reliability of thermal regulation

⚠ Before making the connections, please verify that the control terminal block is on the right-hand side.

⚠ It is mandatory to use ferrules on all conductors, both on the board side and on the wall-mounted terminal block side, to prevent permanent damage to the equipment.

- | | |
|----|----------------------------|
| 1. | Electrical back box |
| 2. | Back plate |
| 3. | Wall-mounted control panel |

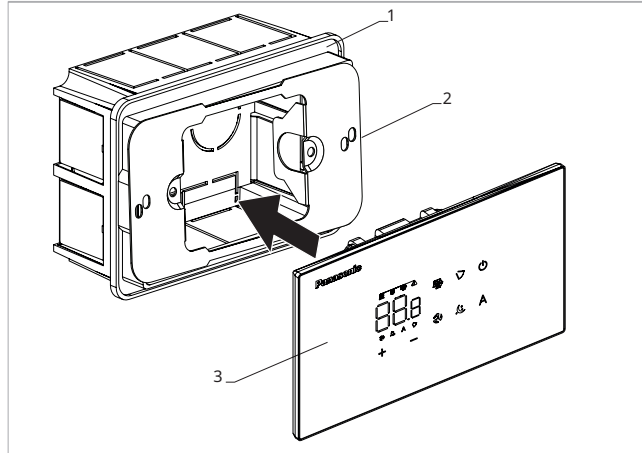

- ▶ Close the control panel

⚠ Pay attention not to crush the conductors when you close the control.

6.3 Single connection diagram

M1	DC fan motor
SM	Step Motor
	Ground connection
230-50	Power supply connection 230 V / 50 Hz / 1 A
Y1	Water solenoid valve (230 V / 50 Hz / 1 A power output)
CH/C1	Cooling request contact (for example chiller or reversible heat pump). Activated in parallel with the solenoid valve output (Y1) with 1 minute delay when the fancoil is in cooling mode and is on call (potential-free contact max. 1 A).
BO/C2	Heating request contact (for example boiler or heat pump). Activated in parallel with the output of the solenoid valve (Y1)

	with 1 minute delay when the fancoil is in heating mode and is on call (potential-free contact max. 1 A).
+BA-	Serial connection for wall-mounted remote control (respect AB polarization)
IN1	Potential-free input 1(not active)
H2/T2	Water temperature probe
CP	Presence contact (normally open)
LU	Electronic board for pairing control and device
PU	Electronic board on the unit
PSM	Electronic board for step motor connection
RC	Wall-mounted control

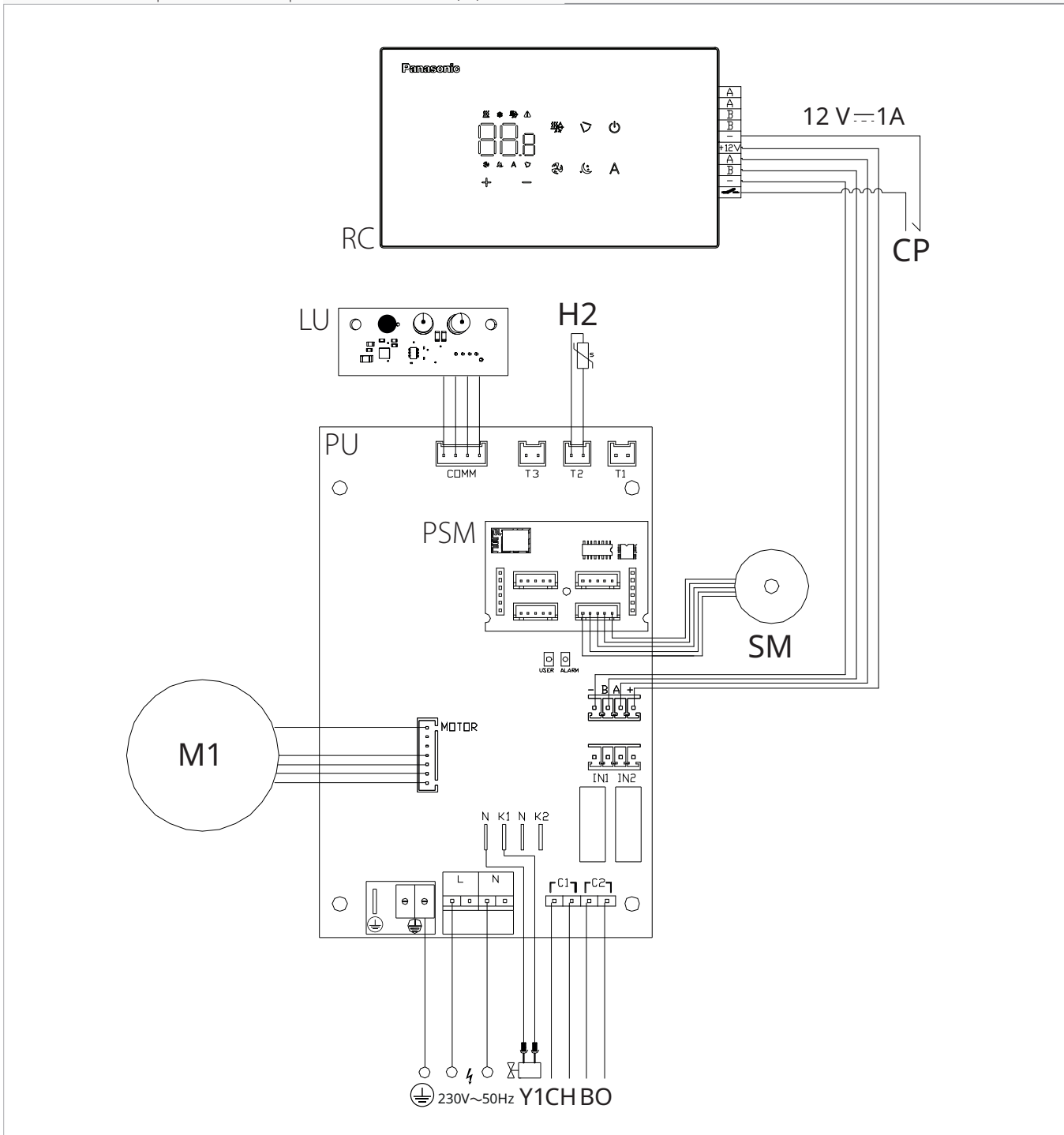

6.4 Multiple connection diagram

- | | | | |
|----|--------------------------------------|----|--------------------------------------|
| 1. | Wall-mounted control panel | 3. | PCB |
| 2. | Terminal block for device connection | 4. | Board for pairing control and device |

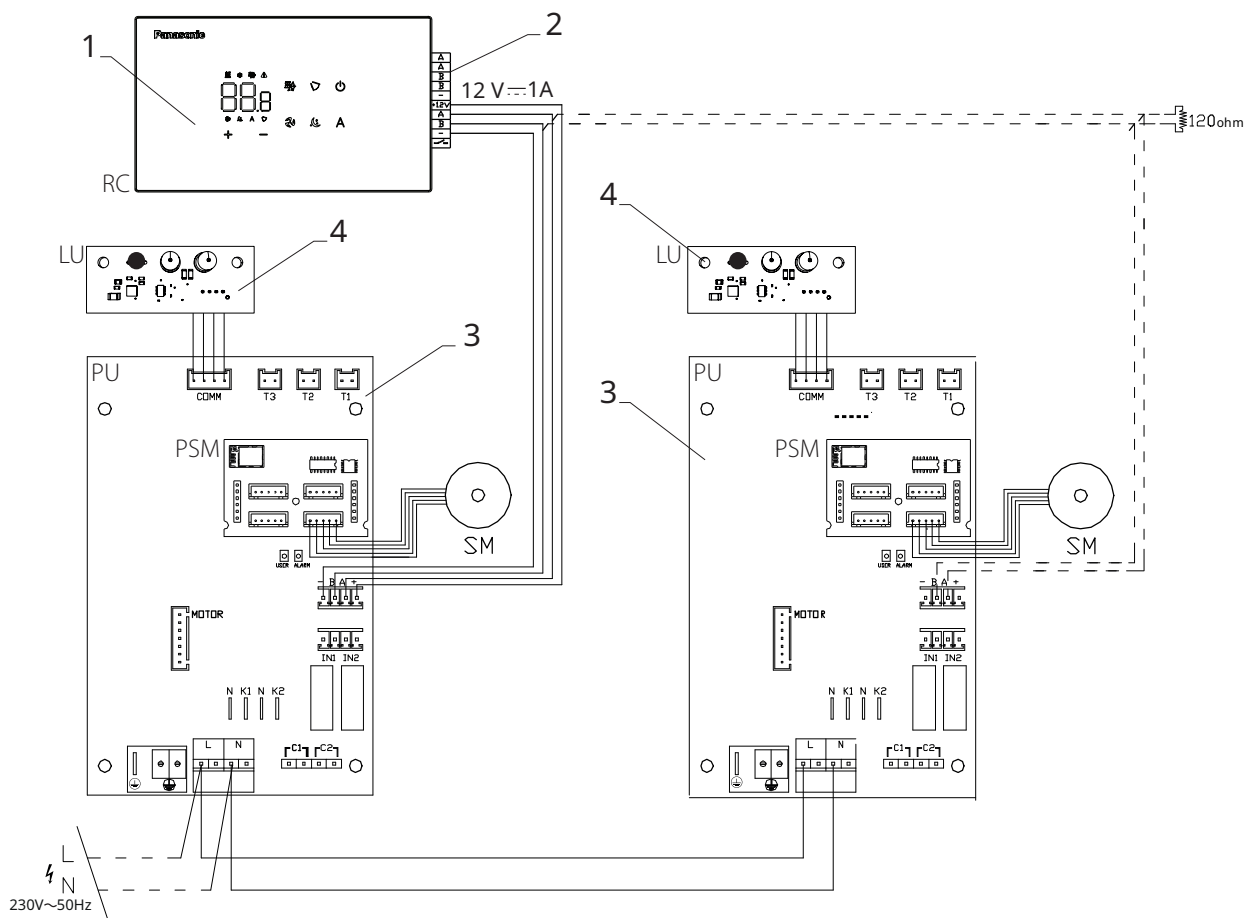

⚠ With multiple command linkage, it is mandatory to perform command-to-device matching. See section "Pairing of control and unit" p. 34.

6.5 Connections

6.5.1 Preliminary warnings

- ⚠ The terminals for connecting the control panel and the presence contact CP are placed in a plastic bag and positioned inside the cover of the electrical box.

1. Terminal blocks

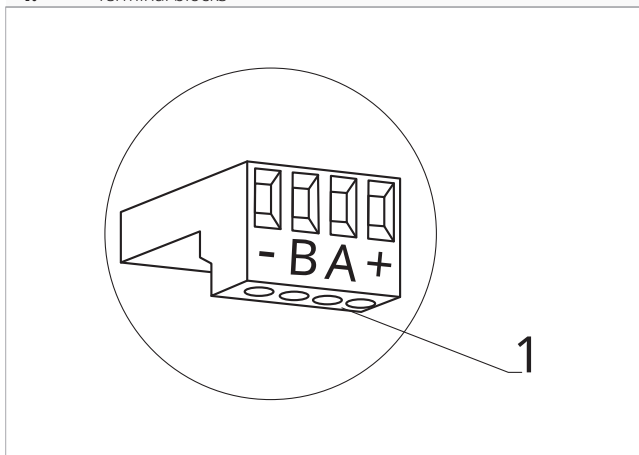

The terminals accept:

- rigid or flexible wires with a 0.2 to 1 mm² cross-section
- rigid or flexible wires with 0,5 mm² cross-section if two wires are connected to the same terminal block
- rigid or flexible wires with 0,75 mm² cross-section if the wires have wire end ferrules with a plastic collar

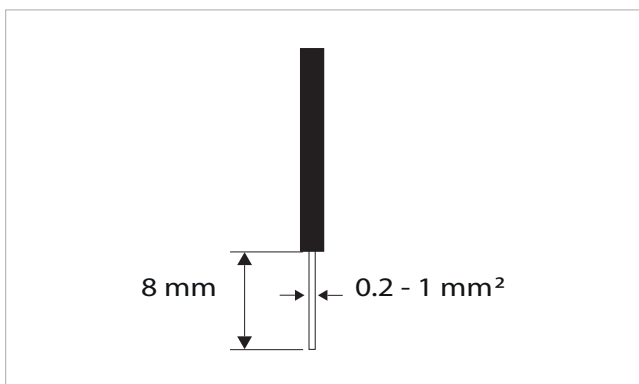

To connect the cables:

- ▶ strip 8 mm of the wire
- ▶ if the wire is rigid, you can insert it easily whereas
- ▶ if it is flexible, use appropriate crimp terminals
- ▶ push the wire in completely
- ▶ check the right fixing by pulling it gently

6.5.2 Control Panel

- ⚠ The control panel for wall control must be ordered separately.

Terminal block position:

1. Terminal block (Back view panel)

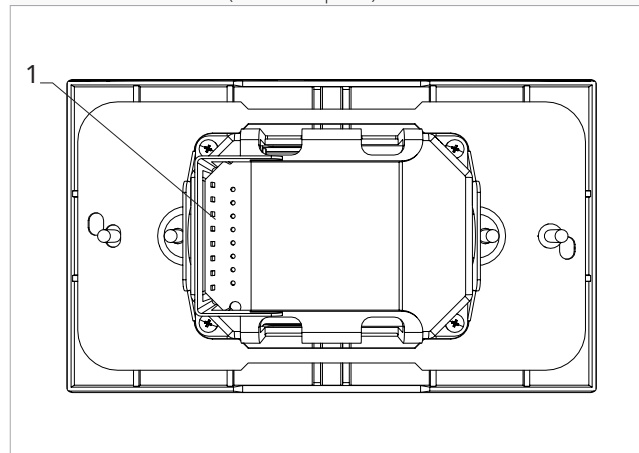

1. Terminal blocks

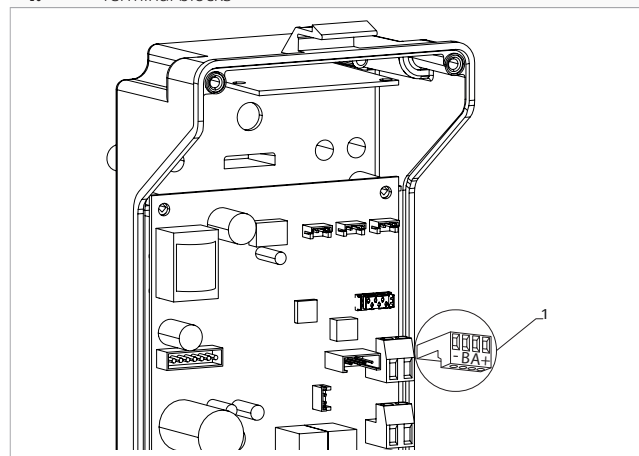

To connect the wall control panel to the board:

- ▶ connect the power supply cables to the + - terminals
- ▶ connect the ModBus serial connection cables to terminals A and B

6.5.3 Presence contact CP

Through this device it is possible to connect an external control signal that inhibits the operation of the control signal, for example:

- opening window contact
- remote on/off
- infrared presence sensor
- activation badge

Function

The contact is normally open (NO).

- ▶ when closing the CP contact, connected to a potential-free contact, the device switches to stand-by mode
- ▶ At the touch of a button on the display the symbol ⚠ flashes.

- ⊖ It is forbidden to connect the CP input to that of another unit electronic board. Use separate contacts.

The CP presence contact can be configured for heating and cooling operation via the "To select digital input" p. 34 settings menu item (digital input).

6.5.4 RS485 Serial Connection

The wall-mounted remote control can be connected through an RS485 serial line to one or more devices, up to a maximum of 16.

The devices must be equipped with an electronic board suitable for remote control.

For the connection:

- ▶ follow the indication on the connection diagram
- ▶ connect respecting the polarity indication A and B

⚠ Use a two core cable shielded cable suitable for the RS485 serial connection with a minimum section of 0,35 mm².

⚠ Keep the two core cable separate from power supply cable by a minimum of 50 mm.

⚠ Create a wire path in order to minimize the length of the lead wire.

⚠ Complete the line with the 120 Ω resistor.

⊖ It is forbidden make star connections.

⚠ In the case of a connection between several devices, it is mandatory to carry out the matching between control and device. See section "Pairing of control and unit" p. 34.



6.6 Functions

6.6.1 Basic menu

To access the basic menu



- ▶ with the display off, hold down  for 10 seconds

The device turns on and  appears

- ▶ keep pressed until the indication  appears
- ▶ release the  key

The symbol  appears

To navigate in the menu

- ▶ use the icons  

To select a menu item and to confirm the changes made

- ▶ press the icon 
 - Confirming the change takes you to the next item.*

To exit the menu

- ▶ press the icon  for 10 seconds
- ▶ or wait 30 seconds after the last action
 - The display is switched off automatically.*

⚠ After 30 seconds from the last action the control returns to the start screen and the last chosen values are recorded.

Menu items

ot: AIR probe offset (air probe setting)

ur: Value read by the R.H. sensor

ut: Probe Offset PT4

uS: Humidity setpoint

ui: Humidity hysteresis

CF: Scale

ub: Buzzer volume





uu: Not used

up: Not used

ho: Hotel Mode

Set AIR probe offset





To set the air probe offset

- ▶ select 
- ▶ press  to change settings
- ▶ increase or decrease the value with the icons  
- ▶ press  to confirm
 - By default it is set to 0.*
 - The setting range is from a minimum of -12.0 °C to a maximum of 12.0 °C.*

Set probe offset RH





⚠ Modify only after real deviations from an actual measurement has been established with professional equipment.

To set the RH probe offset

- ▶ select 
- ▶ press  to change settings
- ▶ increase or decrease the value with the icons  
- ▶ press  to confirm





Set the humidity setpoint

To set the humidity setpoint

- ▶ select 
- ▶ press  to change settings
- ▶ increase or decrease the value with the icons  
- ▶ press  to confirm
 - The setting range is from 20.0% to 90.0%.*



Setting the humidity hysteresis

To set the humidity hysteresis

- ▶ select 
- ▶ press  to change settings
- ▶ increase or decrease the value with the icons  
- ▶ press  to confirm
The setting range is from 1 (min) to 30 (max).





Scale

To change the temperature unit of measure

- ▶ select 
- ▶ press  to change settings
- ▶ select °C or °F
- ▶ press  to confirm
By default the temperature unit of measure is °C.

Adjusting the volume

To change the volume

- ▶ select 
- ▶ press  to change settings
- ▶ increase or decrease the value with the icons  
- ▶ press  to confirm
The volume setting range is from 00 (min) to 03 (max).

 The volume changes after confirming the modification.

Setting the Hotel Mode

To set the Hotel mode

- ▶ select 
- ▶ select YS to turn on Hotel mode
- ▶ select NO to turn off the Hotel mode
By default the device is set to NO.

Activating the Hotel mode:





- the Autochangeover function is deactivated
- the temperature setting range is reduced, in Cooling you can set from 22 °C to 28 °C, in Heating you can set from 16 °C to 24 °C

6.6.2 Advanced Menu



 **To access the setup menu, it is necessary to access the Basic menu. See section "Basic menu" p. 32.**

The special functions menu can be accessed via the control panel.

To access the advanced menu

- ▶ from the basic menu press 
Appears 
- ▶ press the  key once
Appears 
- ▶ press  to confirm and log in
This takes you to the settings menu.



To navigate in the menu

- ▶ use the icons  

To select a menu item and to confirm the changes made

- ▶ press  for 2 seconds
Confirming the change takes you to the next item.

To exit the menu

- ▶ press  for about 10 seconds
Appears 
- ▶ press  for about 10 seconds
The display turns off.
- ▶ or wait 30 seconds after the last action
The display is switched off automatically.

 After 30 seconds from the last action the control returns to the start screen and the last chosen values are recorded.

Menu items

Ad: Not used

Pr: Not used

di: Options for digital input

t1: Select air probe M7/PU

rC: Radiant cooling options with R20

rH: Radiant heating options with R20

UC: Not used

Ac: Anti-stratification in cooling







Ah: Anti-stratification in heating

Ed: Not used

Fr: Not used



Set device address for communication

To set the Modbus address

- ▶ select 
- ▶ press  to change settings
- ▶ press   simultaneously to change the value shown on the display
The value shown in the display flashes.
- ▶ increase or decrease the value with the icons  
- The setting range is from 01 (min) to 99 (max).*
- ▶ press  to confirm
By default the Modbus address is set to 01.

To select digital input

To change the digital input



- ▶ select 
- ▶ press  to change settings
- ▶ select CP for presence contact (default)
- ▶ select CO to cooling open
- ▶ select CC to cooling close
- ▶ press  to confirm

By default digital input is set to CP.

- ⚠ For return to the default settings, set the digital input to "CP".
- ⚠ By selecting one of the other inputs (CO,CC) the seasonality is locked. It is not possible to modify it through the key  of the control.

Select air probe M7/PU

To select the M7/PU air probe

- ▶ select t1
 - ▶ press  to change settings
 - ▶ select 0 to use air probe M7
 - ▶ select 1 to obtain the values of the T1 probes of the connected PU boards
 - ▶ press  to confirm
- By default, the digital input is set to 0.*

- ⚠ In the case of paired PU boards, the M7 series control unit takes an average of the probe values.

Set radiant options in heating with R20







- ⚠ To change the rH function, it is necessary to have the accessory MZS - Single zone module for radiant system.
- ⚠ To change the settings, please refer to the Instruction Sheet of the accessory MZS - Single zone module for radiant system.

Set radiant options to cooling with R20

- ⚠ To change the rC function, it is necessary to have the accessory MZS - Single zone module for radiant system.
- ⚠ To change the settings, please refer to the Instruction Sheet of the accessory MZS - Single zone module for radiant system.

Set the anti-stratification function to cooling







To set the anti-stratification function in cooling mode

- ▶ select 
- ▶ press  to change settings
Appears 
- ▶ press  to move within the menu
- ▶ select  to enable the function
- ▶ press  to confirm changes
By default, the anti-stratification function in cooling is set to .

- ⚠ The anti-stratification function in cooling is to be set for appliances installed at low floor level equipped with an active air probe.

Set the anti-stratification function in heating mode

To set the anti-stratification function in heating mode



- ▶ select 
- ▶ press  to change settings
Appears 
- ▶ press  to move within the menu
- ▶ select  to enable the function
- ▶ press  to confirm changes
By default, the anti-stratification function in heating is set to .

- ⚠ The anti-stratification function in heating is to be set for appliances installed high up on the wall or ceiling equipped with an active air sensor.

6.6.3 Pairing of control and unit

- ⚠ The matching procedure between control and luminaire is mandatory and allows the reception of any alarms.
- ⚠ In the case of a failed pairing between control and device, and the related appearance of error E8, after 10 minutes, the control enables broadcast communication. The E8 error is then eliminated and the control sends signals to all devices without receiving any feedback.

To pair the control with the unit

- ▶ with control switched on, at the same time press  and  for about 10 seconds
In the display area, where the setpoint is indicated, appears the number of connected devices. The displayed value flashes.

1. Red LED
2. Green LED
3. Black button
4. Electrical back box

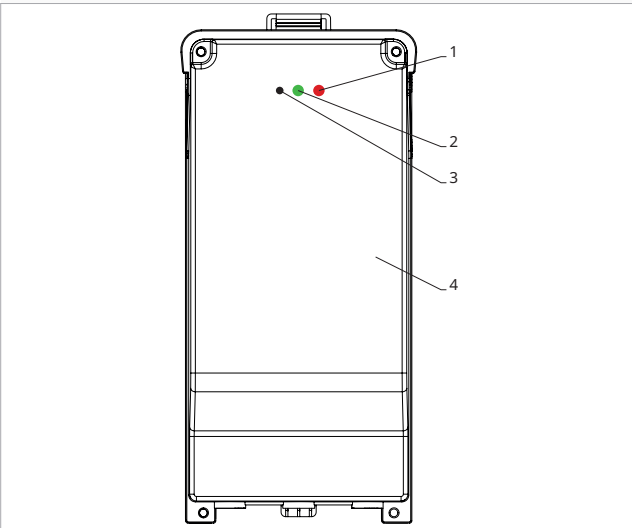

On the electrical box on the unit

- ▶ press the black button for 3 seconds
The green LED flashes.
The red LED is on.
- ▶ wait for the procedure to complete
The green LED stops flashing.

On the wall mounted control panel

- ▶ *Appear the number assigned to the fancoil.*
Then appears the number of connected devices.
- ▶ press to exit the menu

Reset pairing

⚠ **To reset the pairing settings, it is first necessary to access the "Basic menu" p. 32.**

To reset pairing settings

- ▶ access the basic menu
- ▶ press
- ▶ press
- ▶ *All the way to the menu.*
- ▶ press

To reset a single fancoil

- ▶ *Appears*
- ▶ press
- ▶ *Appears*
- ▶ press to access the menu
- ▶ use the icons to move inside the menu
The assignment numbers assigned to the fancoils appears.
- ▶ select the fancoil to be reset
- ▶ press to confirm
-- appears, with an acoustic signal.
The device is removed.

To exit the setting

- ▶ press for 5 seconds
Exit the setting.
Back to menu 02.

To reset all fancoils

- ▶ *Appears*
- ▶ press until appears
- ▶ *Appears*
- ▶ press to access the menu
- ▶ use the icons to move inside the menu
- ▶ select No to maintain all fancoils
- ▶ select Yes to reset the fancoils
- ▶ press to confirm

LED interface operation on the electrical box

If the device is being paired

The green LED flashes.

If the device is paired and functioning

The green LED is on.

If the device has not been paired and is not functional

The green LED is off.
The red LED is on.

If the device is in alarm status

The red LED flashes.

⚠ The red LED flashes according to the type of alarm. To check the alarm type, please refer to the following "Error signals" p. 35 section.

If communication with the board is missing

The green and red LEDs will flash once every second.

6.6.4 Error signals

The PCB has a status LED.

1. LED

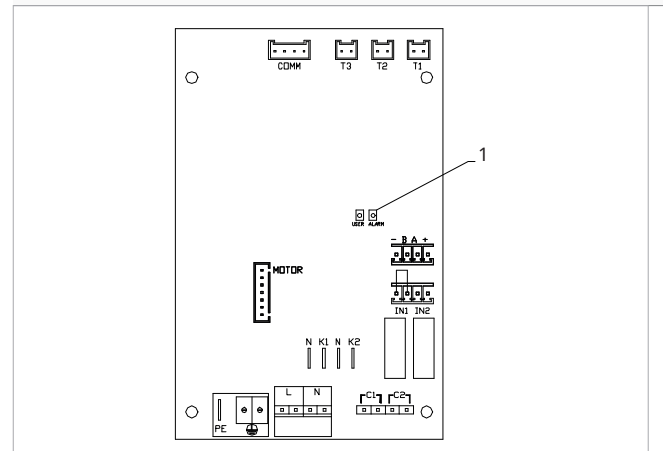

⚠ Once the pairing has been completed, the red LED on the cover of the electrical box performs the same functions as the LED on the board on the unit.

⚠ The flashing LED indicates errors.

⚠ With the LED on and no indication on the display, it is indicated that there are no errors.

LED signals

- ▶ Led flashing
Errors to be shown on the display.

- ▶ LED off
Remote control switched off.
- ▶ LED on
Wall control on and no alarm present.
- ▶ LED continuous flashing with pause between flashes
Unsuitable water temperature alarm.
- ▶ LED 2 flashes / pause
Alarms when the internal fan motor is faulty or disconnected.
- ▶ LED 3 flashes / pause
Alarm for water temperature probe H2/T2 disconnected or faulty.
- ▶ LED 6 flashes / pause
Communication error alarm with wall control panel.



6.6.5 Alarm display on wall control panel

⚠ In the event of an alarm, the device still maintains active functions.

⚠ The symbol  is displayed on the wall control panel to indicate alarms.

⚠ **To access the setup menu, it is necessary to access the Basic menu. See section "Basic menu" p. 32.**

To visualise errors on the wall control panel

- ▶ press 
Appears .
- ▶ press 
Then the number assigned to the fancoil appears and then the error is displayed.

Alarms displayed on the wall control panel

- ▶ E1 Air temperature probe alarm T1 on PUB-30 board disconnected or with incorrect values (-10÷40)
The device is operating and the M7 control uses its own air probe.
- ▶ E2 Internal fan motor faulty or disconnected
None of the modes can be activated.
- ▶ E3 Water temperature sensor H2/T2 disconnected or faulty
None of the modes can be activated.
- ▶ E8 Communication error
Communication error between the wall control panel and the fancoil. No operation of the appliance can be activated.
- ▶ h2o Incorrect water temperature
*In heating mode, the water temperature is below 30 °C
In cooling mode, the water temperature is above 20 °C.*

⚠ Error E8 is displayed without the error display procedure on the wall control panel.

7. WALL-MOUNTED CONTROL CODING PCZ-EFB749

7.1 Interface

1. Display area
2. Keys area

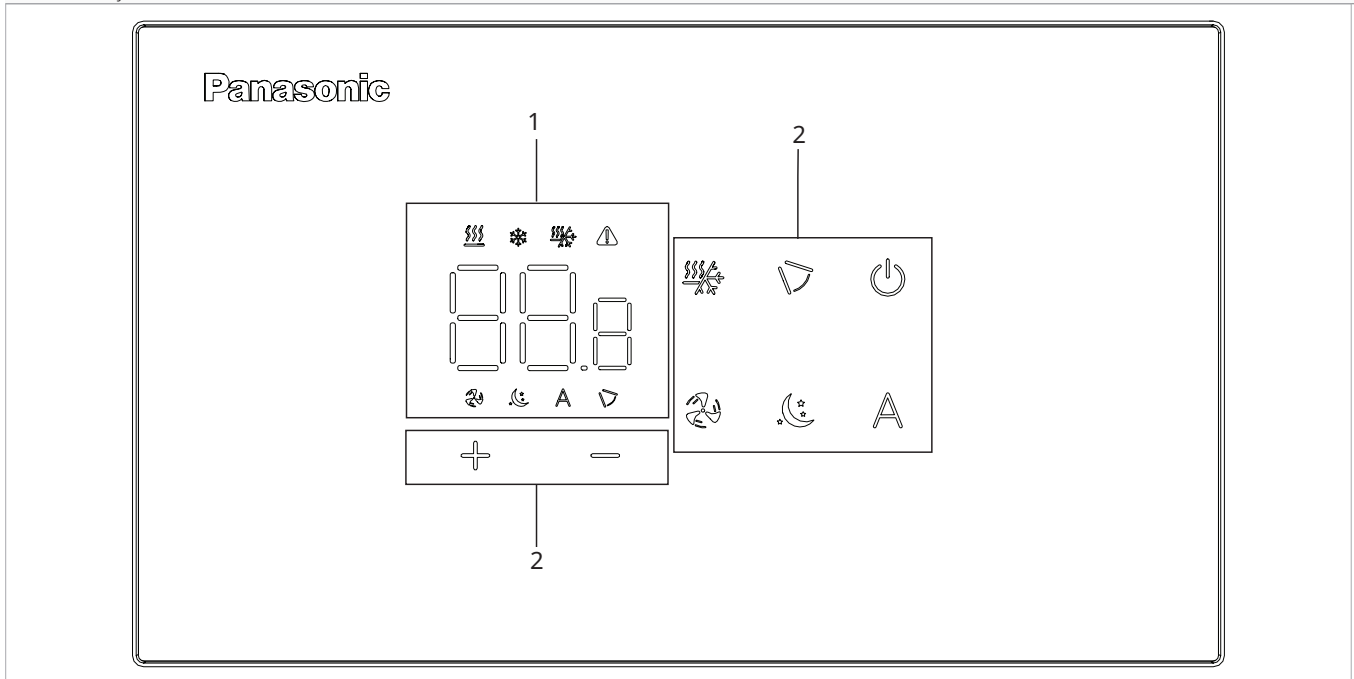

7.2 Installation

7.2.1 Description

The wall-mounted remote control is an electronic LED thermostat with a touch interface, with the possibility of controlling multiple appliances equipped with the same electronic board. It is equipped with a temperature and humidity probe.

- ⚠ The control can manage a maximum of 16 units.
- ⚠ For wall control coding PCZ-EFB749, the Aquarea Home App is available.

7.2.2 Mounting

- ⚠ The control panel must be mounted in an electrical back box.
- ⚠ A wall must be prepared to accommodate the electrical box before installing the wall control.
- ⚠ Ensure that:
 - the wall supports the weight of the appliance
 - the section of the wall does not contain piping or electrical lines

- the functionality of load-bearing elements is not compromised

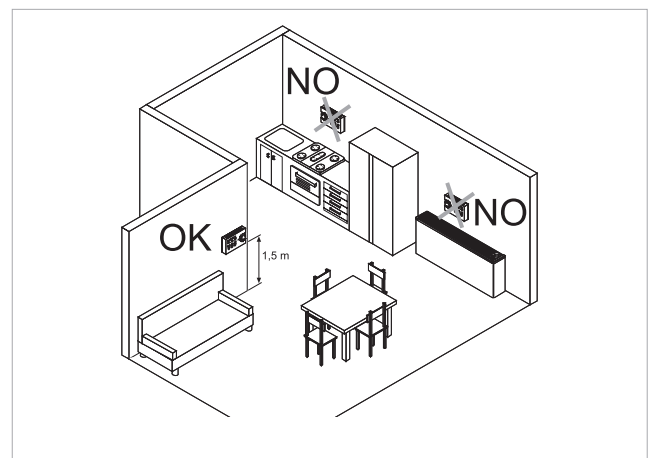

The wall-mounted remote control must be installed:

- on internal walls
- at a height of about 1,5 m from the floor

- ⚠ Should the control be located in an area utilised by persons with reduced physical capabilities, please refer to local regulations.
 - away from doors or windows
 - away from heat sources (heaters, convectors, stoves, direct sunlight)

⚠ The wall control is provided inside the package already assembled.

- | | |
|----|----------------------------|
| 1. | Back plate |
| 2. | Wall-mounted control panel |

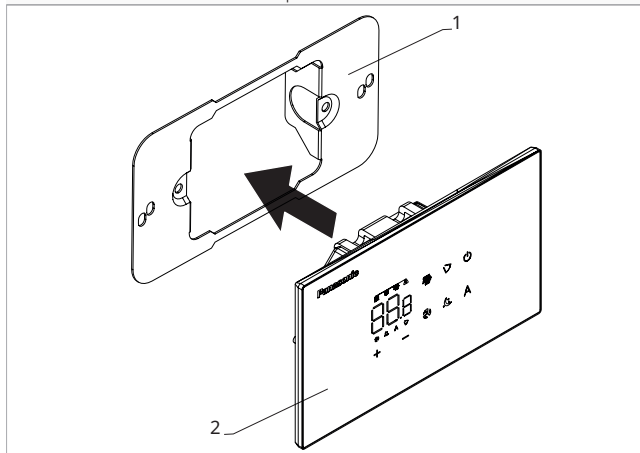

Before wall installation:

- ▶ separate the back plate from the control panel

- | | |
|----|------------------------------------|
| 1. | Fixing screws |
| 2. | Back plate |
| 3. | Holes for fixing to electrical box |
| 4. | Electrical back box |

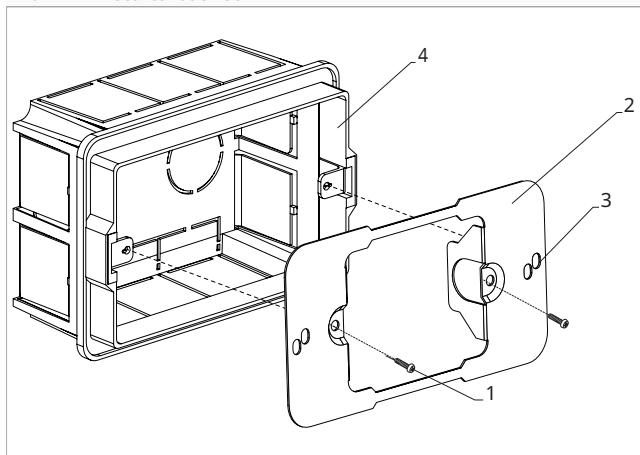

For wall mounting of the control panel:

- ▶ fix the back plate to the electrical back box with screws
- ▶ connect the electrical wiring

⚠ Ensure that the air probe sensor is not affected by air currents, whether warm or cold, coming from the recessed wall box.

⚠ To avoid interference in temperature measurement:

- seal the cable-entry conduits tightly so that they do not allow air to pass through.
- seal any openings in the box or the wall that could connect the back of the thermostat with the air circulating in the wall cavities

⚠ proper sealing ensures the correct operation of the sensor and the reliability of thermal regulation

⚠ Before making the connections, please verify that the control terminal block is on the right-hand side.

⚠ It is mandatory to use ferrules on all conductors, both on the board side and on the wall-mounted terminal block side, to prevent permanent damage to the equipment.

- | | |
|----|----------------------------|
| 1. | Electrical back box |
| 2. | Back plate |
| 3. | Wall-mounted control panel |

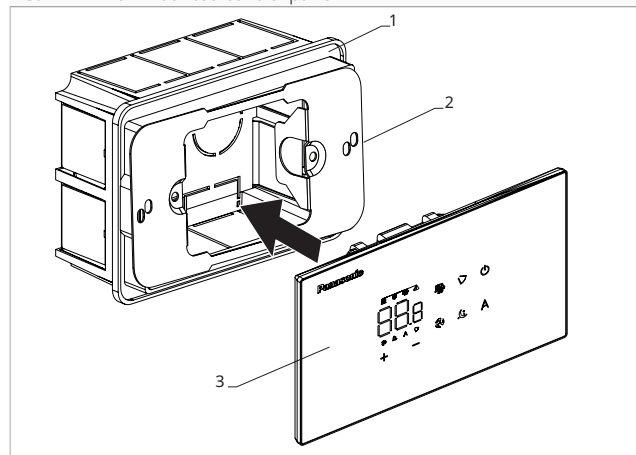

- ▶ Close the control panel

⚠ Pay attention not to crush the conductors when you close the control.

7.3 Single connection diagram

M1	DC fan motor
	Ground connection
230~50	Power supply connection 230 V / 50 Hz / 1 A
Y1	Water solenoid valve (230 V / 50 Hz / 1 A power output)
CH/C1	Cooling request contact (for example chiller or reversible heat pump). Activated in parallel with the solenoid valve output (Y1) with 1 minute delay when the fancoil is in cooling mode and is on call (potential-free contact max. 1 A).
BO/C2	Heating request contact (for example boiler or heat pump). Activated in parallel with the output of the solenoid valve (Y1)

	with 1 minute delay when the fancoil is in heating mode and is on call (potential-free contact max. 1 A).
CP	Presence contact (normally open)
+BA-	Serial connection for wall-mounted remote control (respect AB polarization)
IN1	Potential-free input 1(not active)
H2/T2	2-pipe water temperature probe
LU	Electronic board for pairing control and device
PU	Electronic board on the unit
PSM	Electronic board for step motor connection
RC	Wall-mounted control

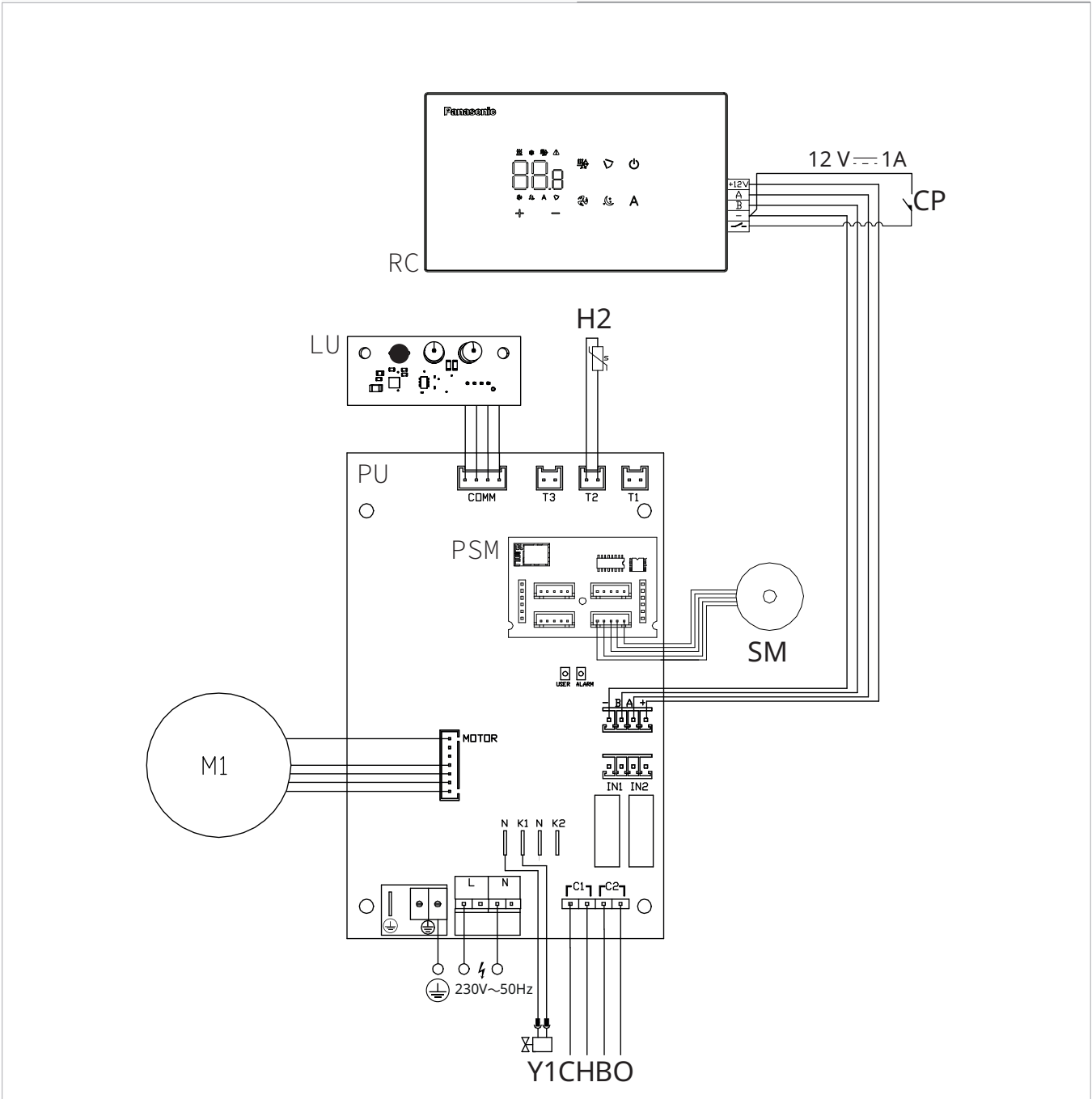

For wall control coding PCZ-EFB749, the Aquarea Home App is available.

7.4 Multiple connection diagram

- | | | | |
|----|--------------------------------------|----|--------------------------------------|
| 1. | Wall-mounted control panel | 3. | PCB |
| 2. | Terminal block for device connection | 4. | Board for pairing control and device |

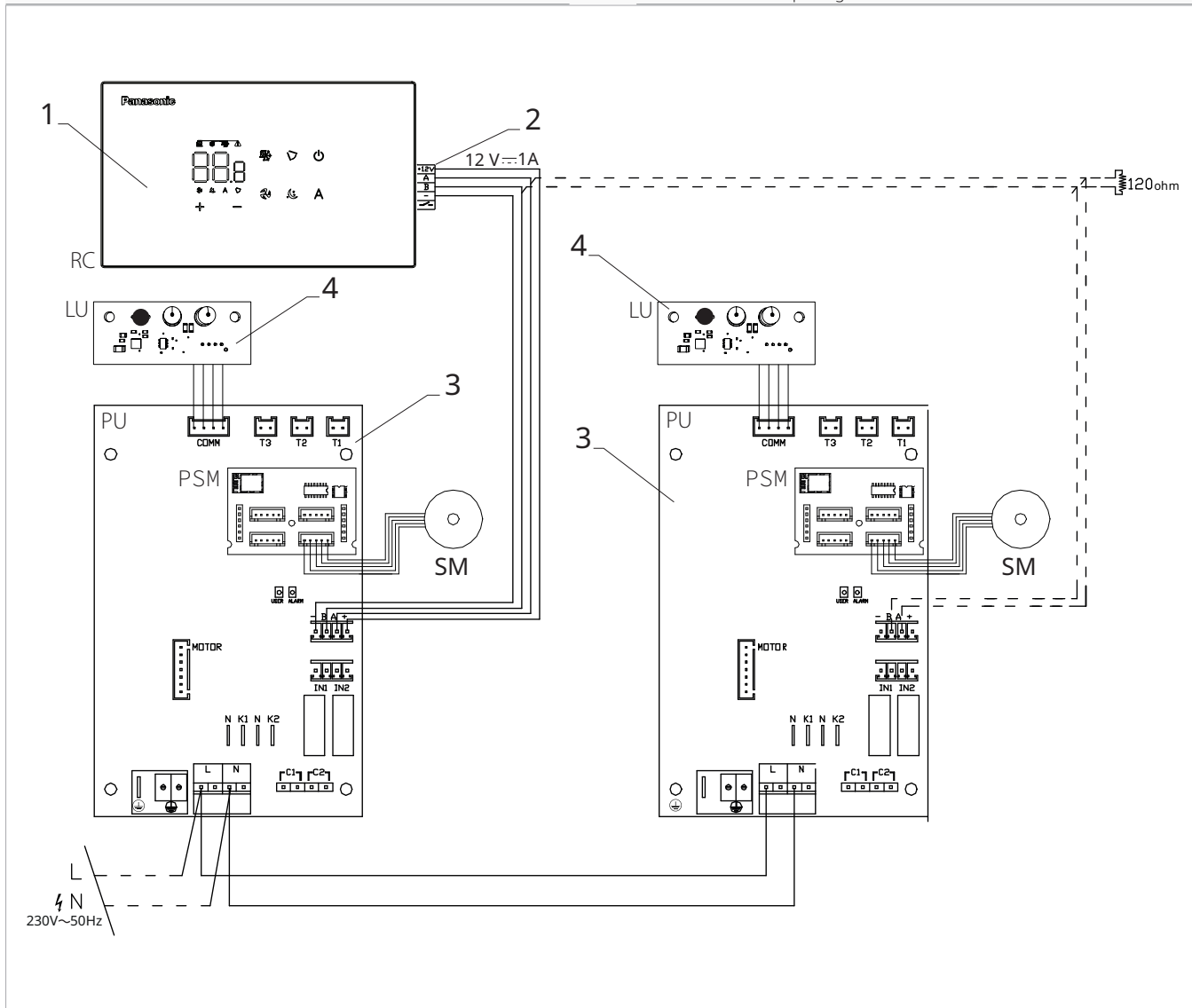

⚠ With multiple command linkage, it is mandatory to perform command-to-device matching. See section "Pairing of control and unit" *p. 44*

7.5 Connections

7.5.1 Preliminary warnings

- ⚠ The terminals for connecting the control panel and the presence contact CP are placed in a plastic bag and positioned inside the cover of the electrical box.

1. Terminal blocks

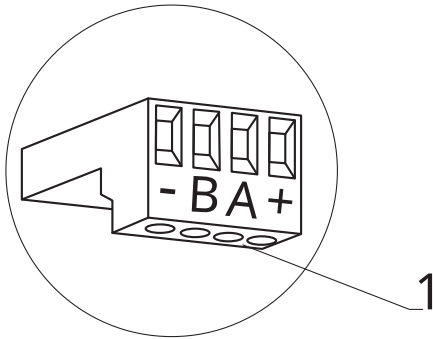

The terminals accept:

- rigid or flexible wires with a 0.2 to 1 mm² cross-section
- rigid or flexible wires with 0,5 mm² cross-section if two wires are connected to the same terminal block
- rigid or flexible wires with 0,75 mm² cross-section If the wires have wire end ferrules with a plastic collar

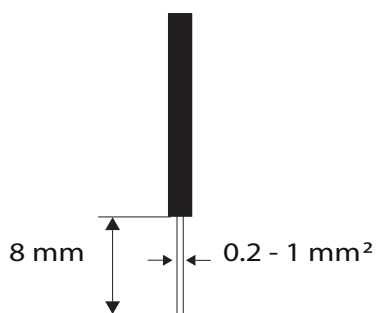

To connect the cables:

- ▶ strip 8 mm of the wire
- ▶ if the wire is rigid, you can insert it easily whereas
- ▶ if it is flexible, use appropriate crimp terminals
- ▶ push the wire in completely
- ▶ check the right fixing by pulling it gently

7.5.2 Control Panel

- ⚠ The control panel for wall control must be ordered separately.

Terminal block position:

1. Terminal block (Back view panel)

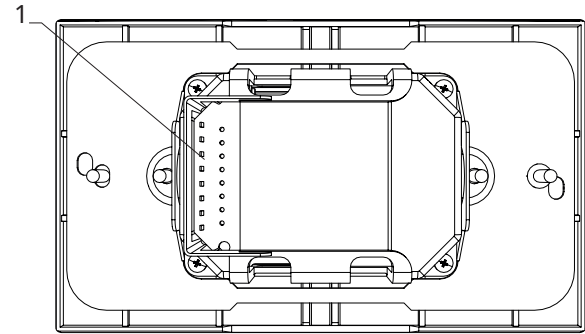

1. Terminal blocks

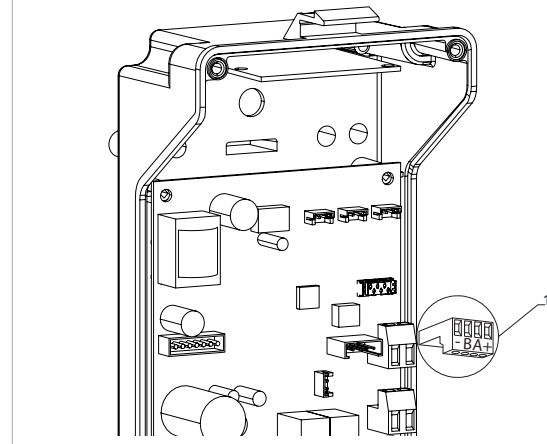

To connect the wall control panel to the board:

- ▶ connect the power supply cables to the + - terminals
- ▶ connect the ModBus serial connection cables to terminals A and B

7.5.3 Presence contact CP

Through this device it is possible to connect an external control signal that inhibits the operation of the control signal, for example:

- opening window contact
- remote on/off
- infrared presence sensor
- activation badge
- remote change of season

Function

The contact is normally open (NO).

- ▶ when closing the CP contact, connected to a potential-free contact, the device switches to stand-by mode
- ▶ At the touch of a button on the display the symbol ⚠ flashes.

- ⊖ It is forbidden to connect the CP input to that of another unit electronic board. Use separate contacts.

The CP presence contact can be configured for heating and cooling operation via the "To select digital input" p. 44 settings menu item (digital input).

7.5.4 RS485 Serial Connection

The wall-mounted remote control can be connected through an RS485 serial line to one or more devices, up to a maximum of 16.

The devices must be equipped with an electronic board suitable for remote control.

For the connection:

- ▶ follow the indication on the connection diagram
- ▶ connect respecting the polarity indication A and B

⚠ Use a two core cable shielded cable suitable for the RS485 serial connection with a minimum section of 0,35 mm².

⚠ Keep the two core cable separate from power supply cable by a minimum of 50 mm.

⚠ Create a wire path in order to minimize the length of the lead wire.

⚠ Complete the line with the 120 Ω resistor.

⊖ It is forbidden make star connections.

⚠ In the case of a connection between multiple devices, it is mandatory to pair the control with the device. See paragraph "Pairing of control and unit" p. 44.



7.6 Functions

7.6.1 Basic menu

To access the basic menu



- ▶ with the display off, hold down  for 10 seconds

The device turns on and  appears

- ▶ keep pressed until the indication  appears
- ▶ release the  key

The symbol  appears

To navigate in the menu

- ▶ use the icons  

To select a menu item and to confirm the changes made

- ▶ press the icon 
 - Confirming the change takes you to the next item.*

To exit the menu

- ▶ press the icon  for 10 seconds
- ▶ or wait 30 seconds after the last action
 - The display is switched off automatically.*

⚠ After 30 seconds from the last action the control returns to the start screen and the last chosen values are recorded.

Menu items

ot: AIR probe offset (air probe setting)

ur: Value read by the R.H. sensor

ut: Probe Offset PT4

uS: Humidity setpoint

uI: Humidity hysteresis

CF: Scale

ub: Buzzer volume





uu: Wi-Fi reset

up: Wi-Fi pairing

ho: Hotel Mode

Set AIR probe offset





To set the air probe offset

- ▶ select 
- ▶ press  to change settings
- ▶ increase or decrease the value with the icons  
- ▶ press  to confirm
 - By default it is set to 0.*
 - The setting range is from a minimum of -12.0 °C to a maximum of 12.0 °C.*

Set probe offset RH





⚠ Modify only after real deviations from an actual measurement has been established with professional equipment.

To set the RH probe offset

- ▶ select 
- ▶ press  to change settings
- ▶ increase or decrease the value with the icons  
- ▶ press  to confirm





Set the humidity setpoint

To set the humidity setpoint

- ▶ select 
- ▶ press  to change settings
- ▶ increase or decrease the value with the icons  
- ▶ press  to confirm
 - The setting range is from 20.0% to 90.0%.*



Setting the humidity hysteresis

To set the humidity hysteresis

- ▶ select 
- ▶ press  to change settings
- ▶ increase or decrease the value with the icons  
- ▶ press  to confirm
The setting range is from 1 (min) to 30 (max).





Scale

To change the temperature unit of measure

- ▶ select 
- ▶ press  to change settings
- ▶ select °C or °F
- ▶ press  to confirm
By default the temperature unit of measure is °C.

Adjusting the volume











To change the volume

- ▶ select 
- ▶ press  to change settings
- ▶ increase or decrease the value with the icons  
- ▶ press  to confirm
The volume setting range is from 00 (min) to 03 (max).

 The volume changes after confirming the modification.











Wi-Fi reset

To reset the Wi-Fi credentials and return the device to its original configuration

- ▶ select 
- ▶ press  to change settings
- ▶ use the   icons in sequence
Appears  .
- ▶ press 
  appears to reset Wi-Fi credentials.
- ▶ press  to confirm
Credentials have been reset.

Activate Wi-Fi

To activate Wi-Fi

- ▶ select 
- ▶ press  to change settings
- ▶ use the   icons in sequence
Appears  .
- ▶ press 
  appears to enable Wi-Fi pairing.
- ▶ press  to confirm

 The device remains visible on Aquarea Home App for the first 15 minutes after the device is switched on.

Setting the Hotel Mode

To set the Hotel mode

- ▶ select 
- ▶ select YS to turn on Hotel mode
- ▶ select NO to turn off the Hotel mode
By default the device is set to NO.

Activating the Hotel mode:





- the Autochangeover function is deactivated
- the temperature setting range is reduced, in Cooling you can set from 22 °C to 28 °C, in Heating you can set from 16 °C to 24 °C

7.6.2 Advanced Menu



 **To access the setup menu, it is necessary to access the Basic menu. See section "Basic menu" p. 42.**

The special functions menu can be accessed via the control panel.

To access the advanced menu

- ▶ from the basic menu press 
Appears .
- ▶ press the  key once
Appears .
- ▶ press  to confirm and log in
The advanced menu is accessed.



To navigate in the menu

- ▶ use the icons  

To select a menu item and to confirm the changes made

- ▶ press  for 2 seconds
Confirming the change takes you to the next item.

To exit the menu

- ▶ press  for about 10 seconds
Appears .
- ▶ press  for about 10 seconds
The display turns off.
- ▶ or wait 30 seconds after the last action
The display is switched off automatically.

 After 30 seconds from the last action the control returns to the start screen and the last chosen values are recorded.

Menu items

Ad: Not used

Pr: Not used

di: Options for digital input

t1: Select air probe M7/PU

rH: Radiant heating options with R20

rC: Radiant cooling options with R20

UC: Not used

Ac: Anti-stratification in cooling



Ah: Anti-stratification in heating

Ed: Not used

Fr: Not used

To select digital input

To change the digital input



- ▶ select  1
 - ▶ press  to change settings
 - ▶ select CP for presence contact (default)
 - ▶ select CO to cooling open
 - ▶ select CC to cooling close
 - ▶ press  to confirm
- By default digital input is set to CP.*

⚠ For return to the default settings, set the digital input to "CP".

⚠ By selecting one of the other inputs (CO,CC) the seasonality is locked. It is not possible to modify it through the key  of the control.

Select air probe M7/PU

To select the M7/PU air probe

- ▶ select t1
 - ▶ press  to change settings
 - ▶ select 0 to use air probe M7
 - ▶ select 1 to obtain the values of the T1 probes of the connected PU boards
 - ▶ press  to confirm
- By default, the digital input is set to 0.*

⚠ In the case of paired PU boards, the M7 series control unit takes an average of the probe values.

Set radiant options in heating with R20

⚠ To change the rH function, it is necessary to have the accessory MZS - Single zone module for radiant system.

⚠ To change the settings, please refer to the Instruction Sheet of the accessory MZS - Single zone module for radiant system.









Set radiant options to cooling with R20

⚠ To change the rC function, it is necessary to have the accessory MZS - Single zone module for radiant system.

⚠ To change the settings, please refer to the Instruction Sheet of the accessory MZS - Single zone module for radiant system.

Set the anti-stratification function to cooling









To set the anti-stratification function in cooling mode

- ▶ select  C
 - ▶ press  to change settings
 - ▶ *Appears  I  I*
 - ▶ press  to move within the menu
 - ▶ select  5 to enable the function
 - ▶ press  to confirm changes
- By default, the anti-stratification function in cooling is set to  I  I*

⚠ The anti-stratification function in cooling is to be set for appliances installed at low floor level equipped with an active air probe.

Set the anti-stratification function in heating mode

To set the anti-stratification function in heating mode

- ▶ select  H
 - ▶ press  to change settings
 - ▶ *Appears  I  I*
 - ▶ press  to move within the menu
 - ▶ select  5 to enable the function
 - ▶ press  to confirm changes
- By default, the anti-stratification function in heating is set to  I  I*



⚠ The anti-stratification function in heating is to be set for appliances installed high up on the wall or ceiling equipped with an active air sensor.

7.6.3 Pairing of control and unit

⚠ The matching procedure between control and luminaire is mandatory and allows the reception of any alarms.

⚠ In the case of a failed pairing between control and device, and the related appearance of error E8, after 10 minutes, the control enables broadcast communication. The E8 error is then eliminated and the control sends signals to all devices without receiving any feedback.

To pair the control with the unit

- ▶ with control switched on, at the same time press  and  for about 10 seconds
- In the display area, where the setpoint is indicated, appears the number of connected devices.
The displayed value flashes.*

1. Red LED
2. Green LED
3. Black button
4. Electrical back box

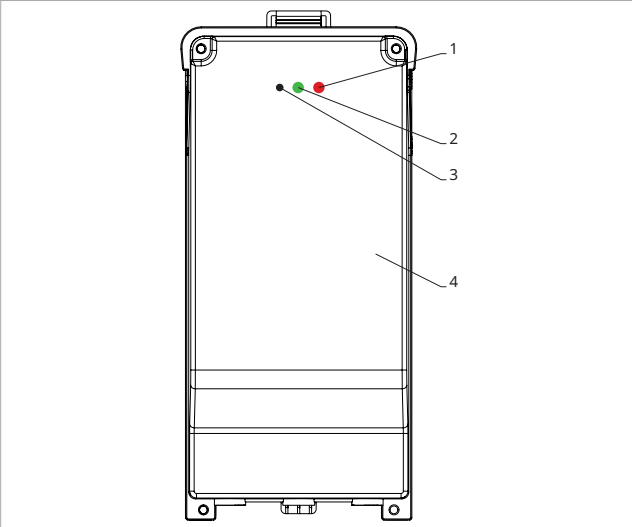

On the electrical box on the unit

- ▶ press the black button for 3 seconds
The green LED flashes.
The red LED is on.
- ▶ wait for the procedure to complete
The green LED stops flashing.

On the wall mounted control panel

- ▶ *Appear the number assigned to the fancoil.*
Then appears the number of connected devices.
- ▶ press to exit the menu

⚠ **To reset the pairing settings, it is first necessary to access the basic menu. See section "Basic menu" p. 42.**

To reset pairing settings

- ▶ access the basic menu
- ▶ press
- ▶ press
- ▶ *All the way to the menu.*
- ▶ press

To reset a single fancoil

- ▶ *Appears .*
- ▶ press
- ▶ *Appears .*
- ▶ press to log in
- ▶ use the icons to move inside the menu
The assignment numbers assigned to the fancoils appears.
- ▶ select the fancoil to be reset
- ▶ press to confirm
-- appears, with an acoustic signal.
The device is removed.

To exit the setting

- ▶ press for 5 seconds
Exit the setting.
Back to menu 02.

To reset all fancoils

- ▶ *Appears .*

- ▶ press until appears
Appears .
- ▶ press to confirm
- ▶ use the icons to move inside the menu
- ▶ select No to maintain all fancoils
- ▶ select Yes to reset the fancoils
- ▶ press to confirm

LED interface operation on the electrical box

If the device is being paired

The green LED flashes.

If the device is paired and functioning

The green LED is on.

If the device has not been paired and is not functional

The green LED is off.
The red LED is on.

If the device is in alarm status

The red LED flashes.

⚠ The red LED flashes according to the type of alarm. To check the alarm type, please refer to the following "Error signals" p. 45 section.

If communication with the board is missing

The green and red LEDs will flash once every second.

7.6.4 Error signals

The PCB has a status LED.

1. LED

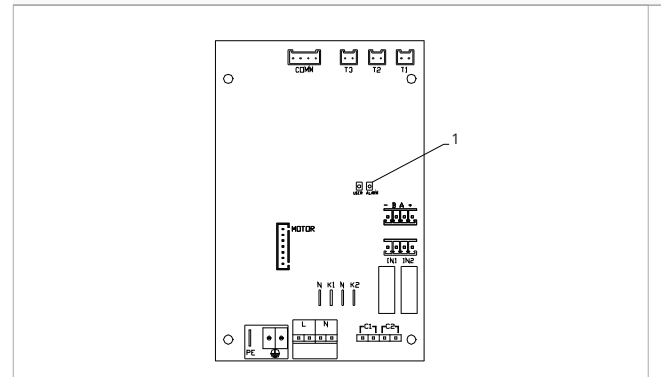

⚠ The LED on the cover of the electrical box performs the same functions as the LED on the machine board.

⚠ The flashing LED indicates errors.

⚠ With the LED on and no indication on the display, it is indicated that there are no errors.

LED signals

- ▶ Led flashing
Errors to be shown on the display.
- ▶ LED off
Remote control switched off.
- ▶ LED continuous flashing with pause between flashes
Unsuitable water temperature alarm.

- ▶ LED on
Wall control on and no alarm present.
- ▶ LED 2 flashes / pause
Alarms when the internal fan motor is faulty or disconnected.
- ▶ LED 3 flashes / pause
Alarm for water temperature probe H2/T2 disconnected or faulty.
- ▶ LED 6 flashes / pause
Communication error alarm with wall control panel.



7.6.5 Alarm display on wall control panel

⚠ In the event of an alarm, the device still maintains active functions.

⚠ The symbol  is displayed on the wall control panel to indicate alarms.

⚠ **To access the setup menu, it is necessary to access the Basic menu. See section "Basic menu" p. 42.**

To visualise errors on the wall control panel

- ▶ press 
Appears .
- ▶ press 
Then the number assigned to the fancoil appears and then the error is displayed.

Displayed alarms

- ▶ E1 Air temperature probe alarm T1 on PUB-30 board disconnected or with incorrect values (-10÷40)
The device is operating and the M7 control uses its own air probe.
- ▶ E2 Internal fan motor faulty or disconnected
None of the modes can be activated.
- ▶ E3 Water temperature sensor H2/T2 disconnected or faulty
None of the modes can be activated.
- ▶ E5 H4/T3 heating water probe disconnected or faulty
None of the modes can be activated.
- ▶ E8 Communication error
Communication error between the wall control panel and the fancoil or when several appliances are combined.
- ▶ h2o Incorrect water temperature
*In heating mode, the water temperature is below 30 °C
In cooling mode, the water temperature is above 20 °C.*

⚠ Error E8 is displayed without the error display procedure on the wall control panel.

8. 0-10 V CONNECTION

8.1 Connection diagram

The PCB is included in the supply.

M1	DC fan motor
SM	Step Motor
	Earth connection
230~50	Power supply connection 230 V / 50 Hz / 1 A

Y1	Water solenoid valve (230 V / 50 Hz / 1 A power output)
10V	Input 0-10 V
F10	Electronic board on the machine
PMS	Electrical board for step motor connection

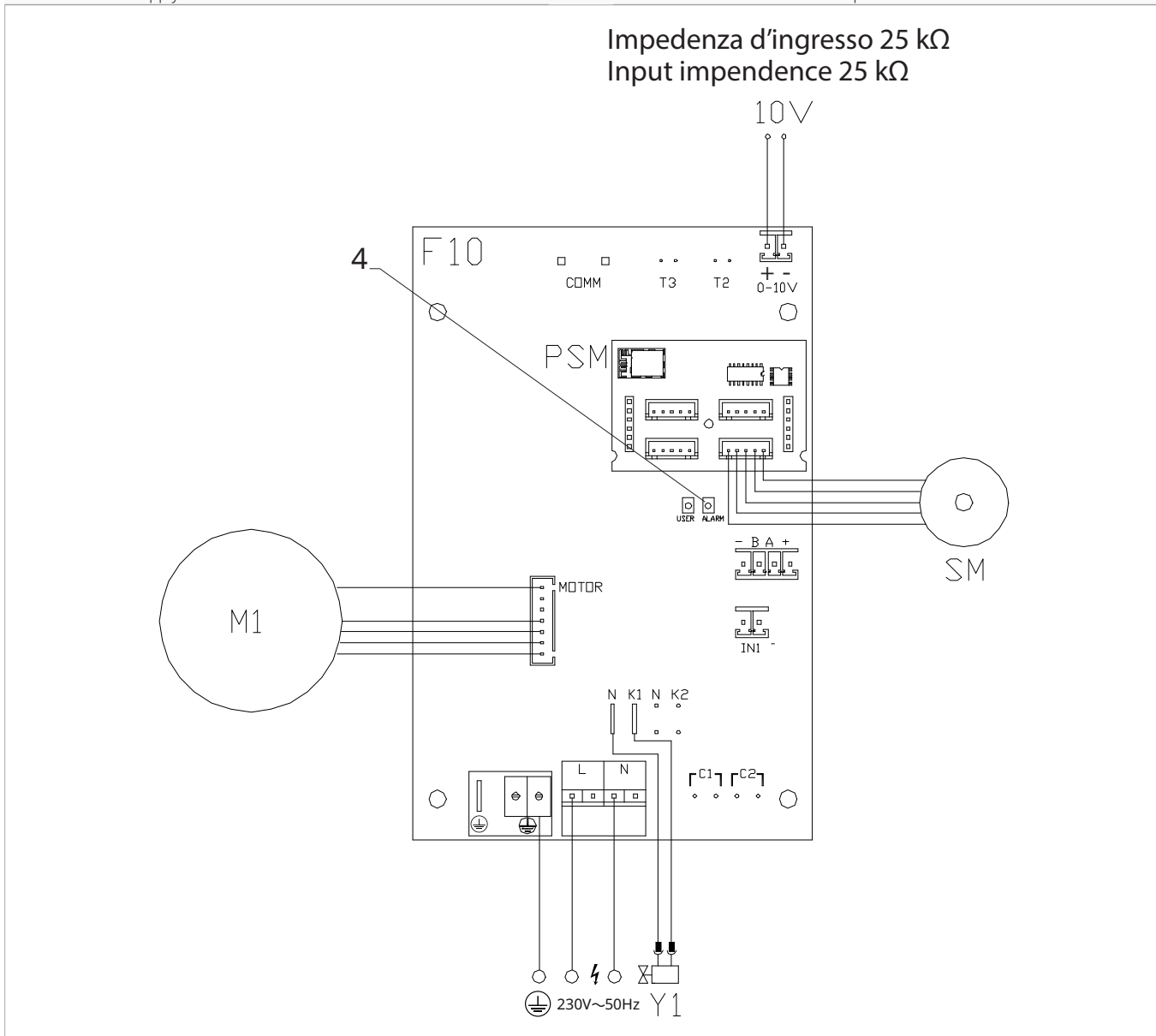

8.2 Connections

The 10 V input activates the Y1 electrovalve and regulates the fan speed.

The speed range provides a linear adjustment from the minimum value (400 rpm) to the maximum value (1500 rpm) for voltage values $\geq 1,1$ V \div 10 V DC.

The solenoid valve Y1:

- is enabled by voltage values > 1 V DC
- turns off with values $< 0,9$ V DC

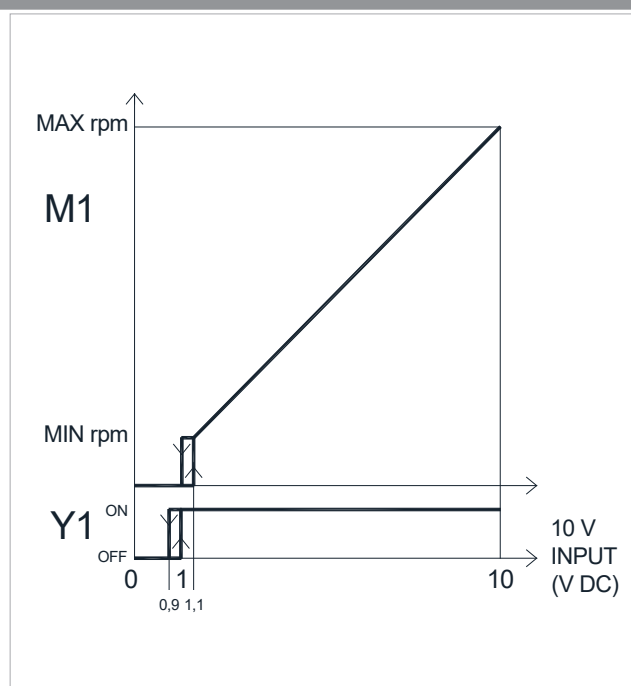

8.3 Error signals

LED signals

- ▶ LED off
The input signal is less than 0.9 V.
- ▶ LED on
Normal operation, the input signal is greater than 1 V.
- ▶ LED 2 flashes / pause
Motor alarm (for example jamming due to foreign bodies or fault in the rotation sensor).

9. MAINTENANCE

Routine maintenance is essential to keep the device always efficient, safe and reliable over time.

9.1 Preliminary warnings

⚠ This section is dedicated to the Authorised Service Centre. The features of the Authorised Service Centre are described in chapter "Recipients" p. 5.

Before each cleaning and maintenance intervention:

- ▶ disconnect the device from the power mains by turning the system master switch to OFF
- ▶ wait for the components to cool down in order to avoid any burns

⊖ Carrying out any technical or cleaning work before disconnecting the unit from the power supply is forbidden.

⚠ Make sure that there is no voltage before servicing.

⚠ After completing the maintenance work, the unit must be restored its original condition.

⚠ Warnings:

- Do not lean or sit on the fancoil to avoid damaging the appliance.
- Do not manually move the horizontal louver of the air outlet. Always use the remote control to do this operation.
- If water leaks from the device, you must switch it off immediately and disconnect the power supply. Then, call the nearest customer service centre.
- The device must not be installed in rooms where there are explosive gases or where there are conditions of humidity and temperature out of the limits defined in the installation manual.
- Clean the filter regularly.

9.2 Routine maintenance

Routine maintenance is essential to keep the device efficient, safe, and reliable over time.

Carry out cleaning:

- every six months

Before each cleaning and maintenance intervention:

- ▶ disconnect the device from the power supply by turning the system main switch to "OFF"

⚠ Wait for the components to cool down in order to avoid any burns.

⚠ After completing the maintenance work, the unit must be restored its original condition.

⊖ It is forbidden to open the access doors and carry out any technical or cleaning intervention, before having disconnected the device from the mains supply by isolating and locking off the main supply, and posting a notice indicating that work is being carried out.

9.3 External cleaning

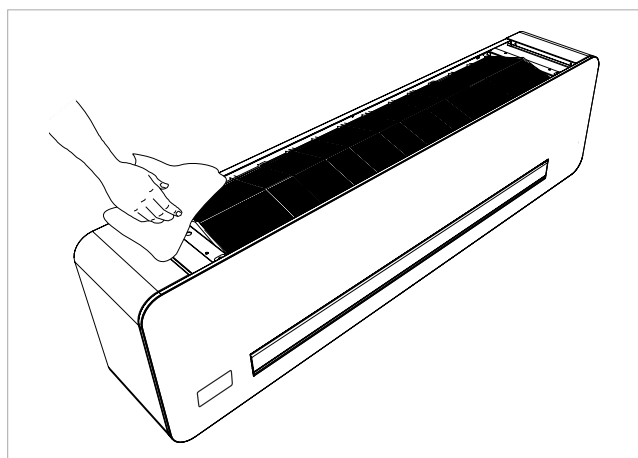

Clean the external surfaces using a soft cloth dampened with water.

⚠ Do not use abrasive sponges, or abrasive or corrosive detergents, as you might damage the painted surface.

⚠ Disconnect the unit from the power supply before each cleaning and maintenance intervention by setting the main power supply switch to off.

9.4 Air intake filter cleaning

Cleaning the filter must be carried out:

- after prolonged operation, consider the concentration of impurities in the air
- when you plan to restart the system after prolonged disuse

To extract the filter:

- ▶ lift it slightly

- ▶ rotate until the complete exit from the housing
- ▶ remove the filter

To clean the filters:

- ▶ use a vacuum cleaner
- ▶ aspirate dust
- ▶ wash the filter with running water
- ▶ allow it dry

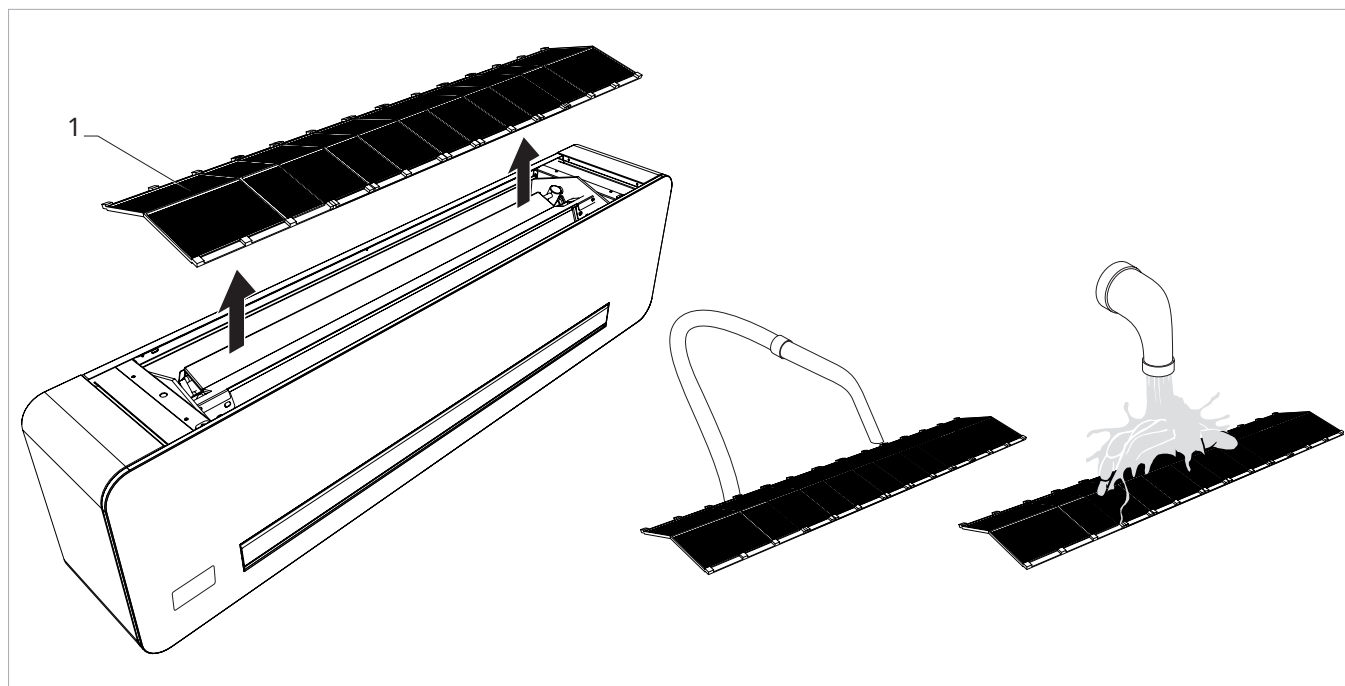

9.4.1 Inserting the filter

Remount the filter paying particular attention to introduce the lower flap in its housing.

⚠ After filter cleaning check if the panel is properly mounted.

⚠ The device features a safety switch that prevents the fan from starting if the mobile panel is incorrectly mounted or the filter are missing.

⊖ It is forbidden to use the device without its mesh filter.

9.5 Suggestions for energy saving

For a correct operation of the device and a greater energy saving:

- keep the filters clean
- keep the doors and windows of the locations fitted with air conditioning systems closed as much as possible
- during summer limit the entry of direct sun rays into the rooms to be air-conditioned by means of external screens (projections, curtains, shutters, etc.)

10. TROUBLESHOOTING

10.1 Preliminary warnings

⚠ For detailed information on accessories please refer to the "Configuration accessories" p. 52 section.

Should you encounter any of the anomalies below:

- the ventilation does not start even if the water circuit is filled with hot or cold water
- the device is losing water in heating mode
- the device is losing water in cooling mode
- the device generates excessive noise
- there is dew on the front panel

Follow the instructions below:

- ▶ disconnect the device from power supply immediately
 - ▶ isolate the water supply
 - ▶ immediately contact an Authorised Service Centre or suitably qualified personnel
- ⚠** The interventions must be carried out by a qualified installer or by an Authorised Service Centre.
- ⊖** Do not intervene personally.

10.2 Troubleshooting table

Effect	Cause	Solution
The ventilation is delayed with respect to the new temperature or function settings.	The circuit valve requires a certain time to open and therefore to make the hot or cold water circulate inside the device.	Wait 2 or 3 minutes to allow the circuit valve to open.
The device does not activate the ventilation.	Cold or hot water is missing from the system.	Ensure the heating or cooling source is on.
The ventilation does not start even if the water circuit is filled with hot or cold water.	The hydraulic valve stays closed.	Demount the body of the valve and check if the water circulation is restored. Check the valve operation, feeding it separately from a 230 V supply. If it operates, the problem may be in the electronic control.
	The ventilation motor is jammed or burnt.	Check the motor windings and check if the fan rotates freely.
	The wirings are not correct.	Check the electrical connections.
The device is losing water in heating mode.	Leaks at the hydraulic connections of the system.	Check the leak and tighten the connection.
	Losses in the valve group.	Check the condition of the gaskets.
There is dew on the front panel.	Detached thermal insulation.	Check the correct positioning of the thermal and acoustic insulations paying particular attention to the front one located on top of the finned coil.
There are water drops on the air vent.	High humidity conditions (>60%) might generate condensation, especially at minimum ventilation speeds.	As soon as the level of relative humidity drops, the phenomena disappears. However, a few water drops falling inside the device will not cause any malfunction.
The device is losing water in cooling mode.	The condensate tray is clogged.	Slowly pour water in the lower section of the coil to check the drainage; if necessary clean the tray and/or improve the slope of the drain pipe.
	The condensate discharge pipe does not have the slope required for correct drainage.	
	The connection pipes and the valves unit are not well insulated.	Check the pipe insulation.
The device generates excessive noise.	The fan touches the structure.	Verify
	The fan is unbalanced.	The unbalancing generates excessive machine vibrations: replace the fan.
	Check the filters cleanliness	Clean filters

11. CONFIGURATION ACCESSORIES

11.1 Shut-off valves

As standard, the unit is supplied without shut-off valves

⚠ The 2-way and 3-way motorized valves are mandatory for the correct operation of the unit.

⚠ The motorized valve can be omitted, inside the unit, if there is a motorized valve in the distribution manifold of the system and connected to the regulation card of the unit.

⚠ 2-way or 3-way motorized valves are available as accessories, see chapter "Compatible accessories" p. 10.

11.1.1 Connection with 2-way valve and thermoelectric actuator (PCZ-V20139)

PCZ-V20139 - 2 way valve group (water inlet valve, shut off valve and electro thermal motor)

In case of choice for the 2-way valve and thermoelectric actuator:

electrical connection are required

- connect to the flow at the bottom

- | | |
|----|--------------------------|
| 1. | Unit |
| 2. | Thermoelectric actuator |
| 3. | Water inlet pipe fitting |

- | | |
|----|-----------------------------|
| 4. | Water outlet pipe fitting |
| 5. | Electrical cable entry hole |

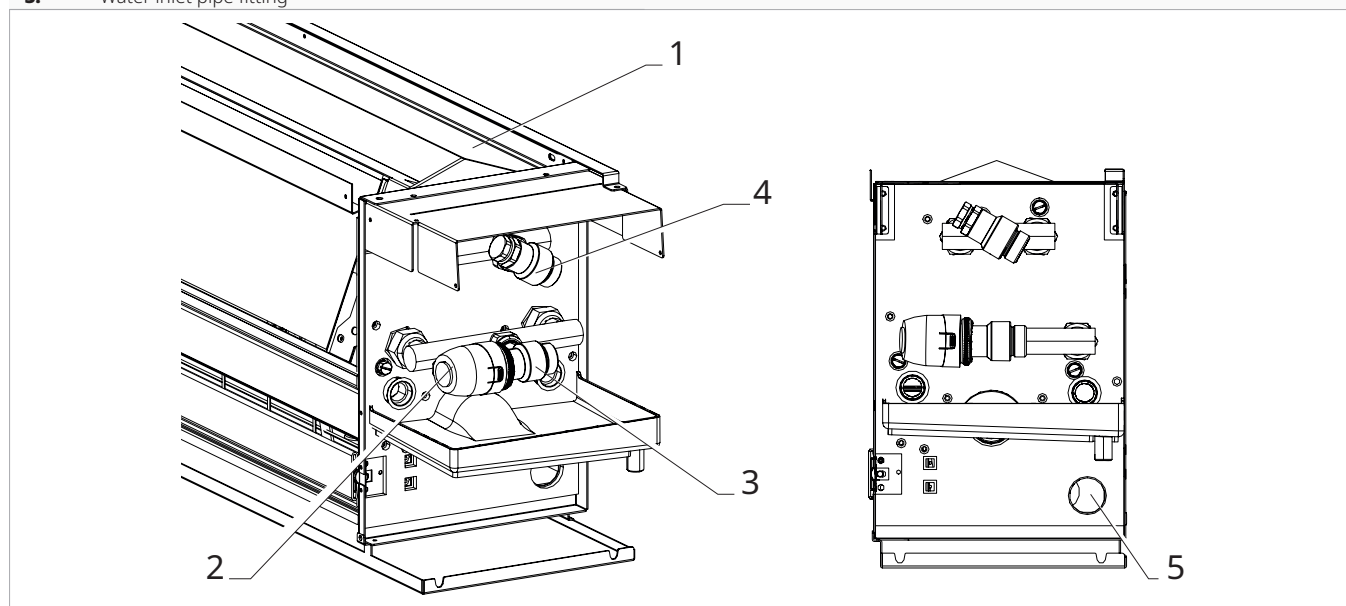

11.1.2 Connection with 3-way diverting valve unit with thermoelectric actuator (PCZ-V30718)

PCZ-V30718II - 3-way diverter valve group with thermoelectric motor (complete with 3-way inlet valve and lock-shield)

In case of choice for the 3-way diverter valve unit with thermoelectric motor:

- electrical connection are required
- connect to the flow at the bottom

- 1. Unit
- 2. Water outlet pipe fitting
- 3. Water inlet pipe fitting

- 4. Thermoelectric actuator
- 5. Electrical cable entry hole

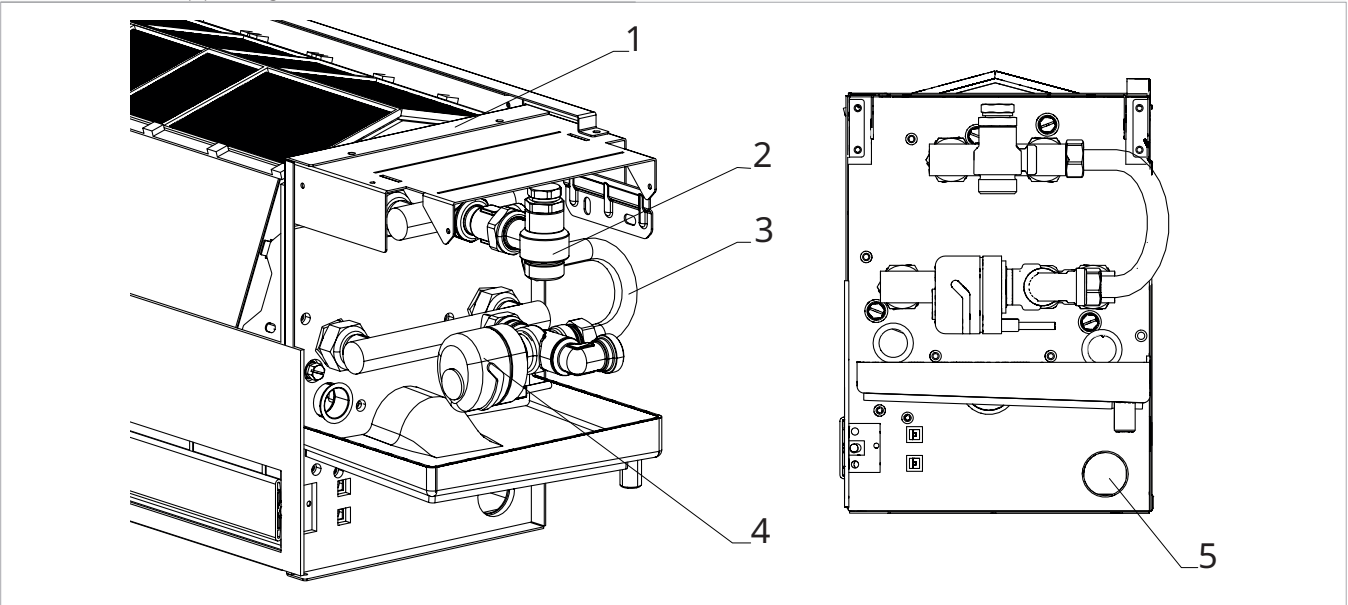

12. TECHNICAL INFORMATION

12.1 Technical data

Models		u.m.	40
Cooling performances (W 7/12 °C; A 27 °C) (1)			
Total cooling capacity		kW	3,12
Sensible cooling capacity		kW	2,51
Water flow		L/h	674
Pressure drop		kPa	12,00
Maximum sound power level	(2)	dB(A)	62
Maximum absorbed power		W	52
Heating performances (W 45/40 °C; A 20 °C) (3)			
Heating capacity		kW	3,45
Water flow		L/h	801
Pressure drop		kPa	12,00
Maximum absorbed power		W	52
Maximum sound power level	(2)	dB(A)	62
Hydraulic data			
Coil water content		L	1,54
Hydraulic connections		" EK	3/4
Aeraulic data			
Maximum air flow		m ³ /h	788
Medium air flow		m ³ /h	480
Minimum flow rate		m ³ /h	230
Static pressure available		Pa	10
Electrical data			
Power supply		V/ph/Hz	230/1/50
Power consumption at the maximum speed		W	30,0
Maximum absorbed current		A	0,25
Sound data			
Sound pressure level at maximum air flow	(4)	dB(A)	51
Sound pressure level at medium air flow	(4)	dB(A)	37
Sound pressure level at minimum air flow	(4)	dB(A)	27

1. Water temperature in coil inlet 7 °C, Water temperature in coil outlet 12 °C, Room air temperature 27 °C DB and 19 °C WB (according to EN 1397) - maximum speed and head 0 Pa
2. Sound pressure measured according to EN 16583
3. Water temperature in coil inlet 45 °C, Water temperature at coil outlet 40 °C, Room air temperature 20 °C DB and 15 °C WB (according to EN 1397) - maximum speed and head 0 Pa
4. Sound pressure measured at a distance of 1 meter according to ISO 7779

12.2 Limits of product operation

		Heating	Cooling
Minimum water inlet temperature	°C	4	4
Maximum water inlet temperature	°C	80	80
Minimum room air temperature	°C	5	5
Maximum room air temperature	°C	32	32
Maximum water-side pressure	kPa	1000	1000

12.3 Limits of operation of the control

	u.d.m.	Heating	Cooling
Minimum room relative humidity	%	15	15
Maximum room relative humidity	%	80	80
Minimum room air temperature	°C	-10	-10
Maximum room air temperature	°C	50	50

12.4 Dimensions

- A** Lateral view
B Front view

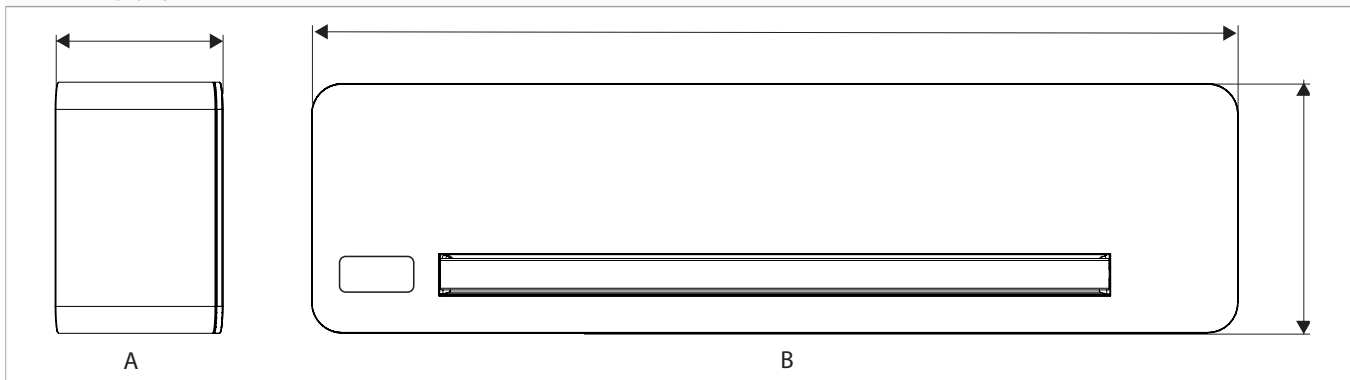

		P-FMM**
Models	u.m.	40
Product dimensions and weight		
Width	mm	1245
Height	mm	335
Total depth	mm	215
Net weight	kg	24,0

12.5 Installation template

! The units are supplied with a paper template for marking the holes necessary for installation.

Installation template

1.	Outlet for left hydraulic connections	6.	Top perimeter of the unit
2.	Electrical connections zone for left installation	7.	Prepare box for built for hydarulic flexible connections for right installation
3.	Prepare box for built for hydarulic flexible connections for left installation	8.	Electrical connections zone for right installation
4.	Holes for dowels, Ø8	9.	Outlet for right hydraulic connections
5.	Minimum distance from the ceiling	10.	Lower perimeter of the machine

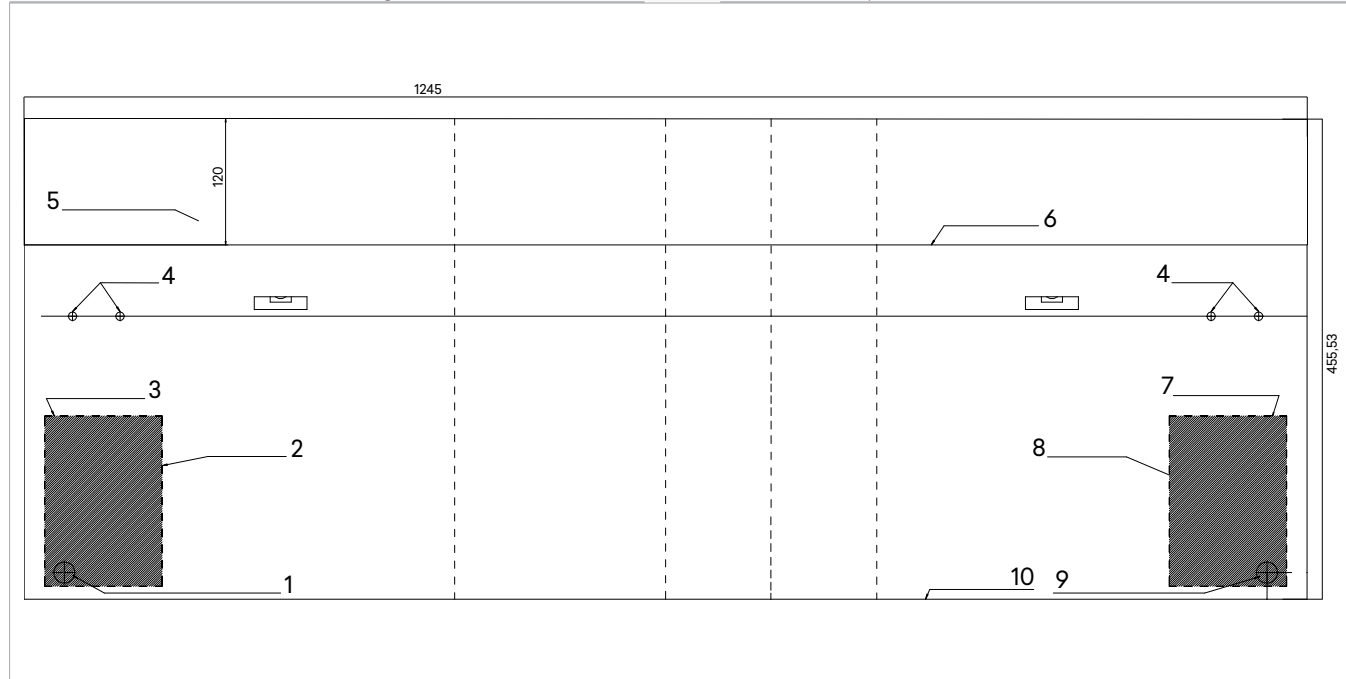

Panasonic[®]

Panasonic Corporation
1006 Kadoma, Kadoma City, Osaka, Japan